



## Bourdon tube pressure gauge RF63RG

Part no. 87056302

Bourdon tube pressure gauge for ultra-pure gas applications type D3

### benefits

- wetted parts specially cleaned, flushed and electropolished
- tightness-tested with helium
- rear blow-out
- versatile connection technology
- GOSSTANDART-certified

### Application

Designed for highly demanding applications in terms of surface quality and purity of the wetted parts, particularly for measuring ultra-pure gases. ! For measuring gas or vapour, observe the table "Selection Criteria as per EN 837-2" (see appendix)!

### Technical Specifications

**Type**  
D3

**Nominal size**  
63

**accuracy class (EN 837-1/6)**  
1.6

**ranges (EN 837-1/5)**  
see ordering table

**Calibration medium**  
Nitrogen or dried air

**application area**  
static load:  $\frac{3}{4}$  x full scale value  
dynamic load:  $\frac{2}{3}$  x full scale value  
short-term: Full scale value

### Operating temperature range

Medium: max. 150 °C  
Ambient: -20/+60 °C

### Temperature performance

Indication error when the temperature of the measuring system deviates from the normal temperature of 20 °C:  
at rising temperature approx.  $\pm 0.4$  %/10 K  
falling temperature approx.  $\pm 0.4$  %/10 K  
of full scale value

### Degree of protection

IP 32 (EN 60529)

### Connection

stainless steel 316 Ti/316 L, bottom  
9/16-18 UNF, with pressure screw

**Measuring element**

Bourdon tube, stainless steel 316 Ti/316 L  
≤ 60 bar: "C" type tube  
> 60 bar: helical tube  
tightness-tested with helium,  
leak rate ≤ 10<sup>-9</sup> mbar x l/s

**wetted parts**

Connection, Measuring element  
stainless steel 316 Ti/316 L  
cleaned, flushed with nitrogen, electropolished, surface roughness  
≤ R<sub>a</sub> 0.6 μm

**movement**

Stainless steel

**Options**

- surface roughness R<sub>a</sub> 0.4 μm
- Housing polished
- Push on bezel polished
- Electrical contacts
- NG 50
- special scales
- other process connections

**Dial**

Aluminium, white  
Scaling: black  
label: ultra-pure gas

**Pointer**

Aluminium, black

**Housing**

Stainless steel 304, with rear blow-out

**push on bezel**

Stainless steel 304, bare metal surface

**window**

Plastic

**Technical Drawings**

**Bottom connection, 9/16-18 UNF, with pressure screw**

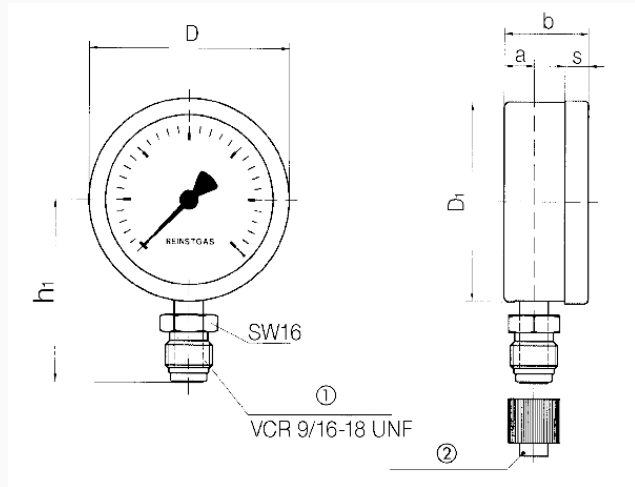

Compression screw  
Protective cover

**Dimensions (mm)**

NG	a	b	D	D1	h1	s
63	9	28	63	62	57	8

**Versions**

Range	Mounting type	Type	Part number
-1/+9 bar	direct	RF63RG D302	87056302

- in-stock items
- Non-stock items