



Glycerine filled Bourdon tube pressure gauges RF40Gly

Part no. 85015611

Glycerine filled Bourdon tube pressure gauges Type D6

benefits

- can be used in case of heavy vibrations and high, dynamic pressure loads
- longer service life due to less wear and corrosion protection of the measuring system
- No steaming up of the inside of the window in case of outdoor applications

Application

For gaseous and liquid media which are not highly viscous, do not crystallise and do not attack copper alloys. For measurements in areas with high vibration levels and high, dynamic pressure loads.

Technical Specifications

Type
D6

Nominal size
40

accuracy class (EN 837-1/6)
1.6

ranges (EN 837-1/5)
see ordering table

application area
static load: $\frac{3}{4}$ x full scale value
dynamic load: $\frac{2}{3}$ x full scale value
short-term: Full scale value

Operating temperature range
Medium: max. 60 °C
Ambient: -20/+60 °C

Degree of protection
IP 54 (EN 60529) with housing vent (≤ 25 bar)

Connection
Brass, centre back

Measuring element
Bourdon tube, Copper alloy
 ≤ 60 bar: "C" type tube
> 60 bar: helical tube

movement
Brass

Dial
NG 40
Plastic, white
Scaling: black

Pointer
NG 40
Plastic, black

Housing
NG 40
Plastic (ABS), black
with blow-out

crimped bezel
NG 40

window

NG 40

Plastic, with housing ultrasonically welded

filling liquid

glycerine (99.5 %)

Options

- Back flange (NG 63)
- clamp fixing (NG 50/63)
- 3-hole fixing, panel mounting bezel (NG 63)
- throttle screw
- special scales
- other process connections

Technical Drawings

NG 40 – centre back connection

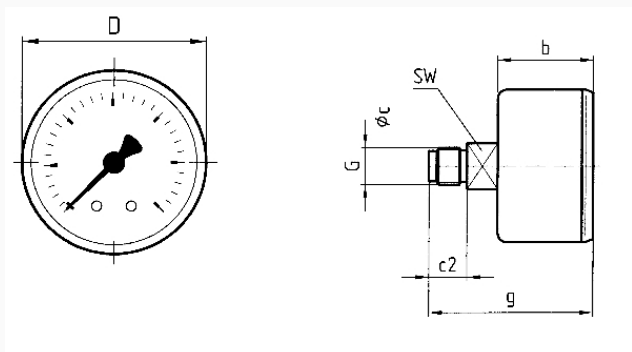

Dimensions (mm)

NG	b	∅c	c2	D	G	g	SW
40	25	4	10	40	G $\frac{1}{2}$ B	43	12

Versions

Range	Mounting type	Type	Part number
0/10 bar	direct	RF40Gly D611	85015611

- in-stock items
- Non-stock items