



## Glycerine filled Bourdon tube pressure gauges RF40Gly

Part no. 85018611

Glycerine filled Bourdon tube pressure gauges Type D6

### benefits

- can be used in case of heavy vibrations and high, dynamic pressure loads
- longer service life due to less wear and corrosion protection of the measuring system
- No steaming up of the inside of the window in case of outdoor applications

### Application

For gaseous and liquid media which are not highly viscous, do not crystallise and do not attack copper alloys. For measurements in areas with high vibration levels and high, dynamic pressure loads.

### Technical Specifications

**Type**  
D6

**Nominal size**  
40

**accuracy class (EN 837-1/6)**  
1.6

**ranges (EN 837-1/5)**  
see ordering table

**application area**  
static load:  $\frac{3}{4}$  x full scale value  
dynamic load:  $\frac{2}{3}$  x full scale value  
short-term: Full scale value

**Operating temperature range**  
Medium: max. 60 °C  
Ambient: -20/+60 °C

**Degree of protection**  
IP 65 (EN 60529)

**Connection**  
Brass, centre back

**Measuring element**  
Bourdon tube, Copper alloy  
≤ 60 bar: "C" type tube  
> 60 bar: helical tube

**movement**  
Brass

**Dial**  
NG 40  
Plastic, white  
Scaling: black

**Pointer**  
NG 40  
Plastic, black

**Housing**  
NG 40  
Plastic (ABS), black  
with blow-out

**crimped bezel**  
NG 40

**window**

NG 40

Plastic, with housing ultrasonically welded

**filling liquid**

glycerine (99.5 %)

**Options**

- Back flange (NG 63)
- clamp fixing (NG 50/63)
- 3-hole fixing, panel mounting bezel (NG 63)
- throttle screw
- special scales
- other process connections

**Technical Drawings**

**NG 40 – centre back connection**

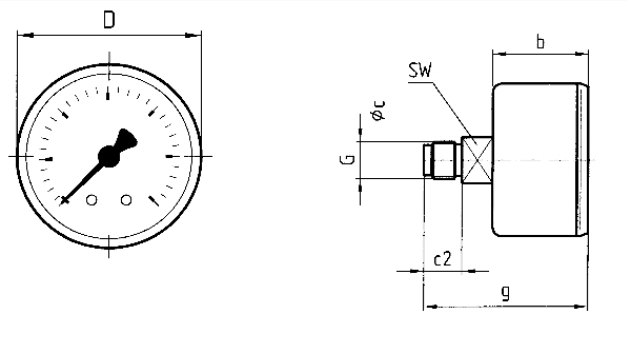

**Dimensions (mm)**

NG	b	øc	c2	D	G	g	SW
40	25	4	10	40	G $\frac{1}{2}$ B	43	12

**Versions**

Range	Mounting type	Type	Part number
0/40 bar	direct	RF40Gly D611	85018611

- in-stock items
- Non-stock items