



Glycerine filled Bourdon tube pressure gauges RF63Gly

Part no. 85119611

Glycerine filled Bourdon tube pressure gauges Type D6

benefits

- can be used in case of heavy vibrations and high, dynamic pressure loads
- longer service life due to less wear and corrosion protection of the measuring system
- No steaming up of the inside of the window in case of outdoor applications

Application

For gaseous and liquid media which are not highly viscous, do not crystallise and do not attack copper alloys. For measurements in areas with high vibration levels and high, dynamic pressure loads.

Technical Specifications

Type

D6

Nominal size

63

accuracy class (EN 837-1/6)

1.6

ranges (EN 837-1/5)

see ordering table

application area

static load: $\frac{3}{4}$ x full scale value
dynamic load: $\frac{2}{3}$ x full scale value
short-term: Full scale value

Operating temperature range

Medium: max. 60 °C
Ambient: -20/+60 °C

Degree of protection

IP 65 (EN 60529)

Connection

Brass, centre back

Measuring element

Bourdon tube, Copper alloy
≤ 60 bar: "C" type tube
> 60 bar: helical tube

movement

Brass

Dial

NG 63
Aluminium, white
Scaling: black

Pointer

NG 63
Aluminium, black

Housing

NG 63
Polyamide, black
with blow-out

crimped bezel

NG 63
Aluminium, black

window

NG 63
Plastic

filling liquid

glycerine (99.5 %)

Options

- Back flange (NG 63)
- clamp fixing (NG 50/63)
- 3-hole fixing, panel mounting bezel (NG 63)
- throttle screw
- special scales
- other process connections

Technical Drawings

NG 50/63 – centre back connection

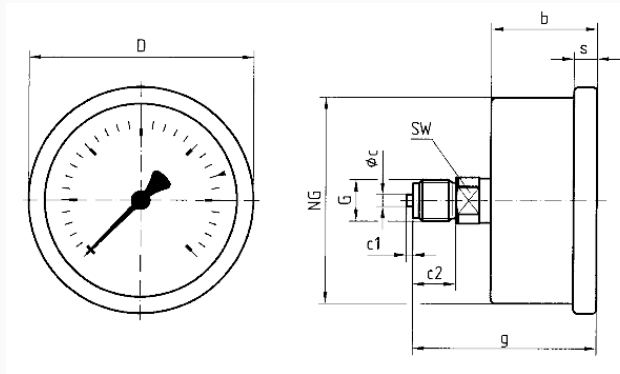

Dimensions (mm)

NG	b	∅c	c1	c2	D	G	g	s	SW
50	31,5	5	2	13	53	G¼B	54,5	5	14
63	32	5	2	13	68	G¼B	55	7	14

Versions

Range	Mounting type	Type	Part number
0/60 bar	direct	RF63Gly D611	85119611

- in-stock items
- Non-stock items