

## Glycerine filled Bourdon tube pressure gauges RF50Gly

Part no. 85071641

Glycerine filled Bourdon tube pressure gauges Type D6

### benefits

- can be used in case of heavy vibrations and high, dynamic pressure loads
- longer service life due to less wear and corrosion protection of the measuring system
- No steaming up of the inside of the window in case of outdoor applications

### Application

For gaseous and liquid media which are not highly viscous, do not crystallise and do not attack copper alloys. For measurements in areas with high vibration levels and high, dynamic pressure loads.

### Technical Specifications

#### Type

D6

#### Nominal size

50

#### accuracy class (EN 837-1/6)

1.6

#### ranges (EN 837-1/5)

see ordering table

#### application area

static load:  $\frac{3}{4}$  x full scale value  
dynamic load:  $\frac{2}{3}$  x full scale value  
short-term: Full scale value

#### Operating temperature range

Medium: max. 60 °C  
Ambient: -20/+60 °C

#### Degree of protection

IP 65 (EN 60529)

#### Connection

Brass, centre back

#### Measuring element

Bourdon tube, Copper alloy  
≤ 60 bar: "C" type tube  
> 60 bar: helical tube

#### movement

Brass

#### Dial

NG 50  
Aluminium, white  
Scaling: black

#### Pointer

NG 50  
Aluminium, black

**Housing**

NG 50  
Polyamide, black  
with blow-out

**window**

NG 50  
Plastic

**crimped bezel**

NG 50  
Aluminium, black

**filling liquid**

glycerine (99.5 %)

**Options**

- Back flange (NG 63)
- clamp fixing (NG 50/63)
- 3-hole fixing, panel mounting bezel (NG 63)
- throttle screw
- special scales
- other process connections

**Technical Drawings**

Centre back connection, with clamp fixing

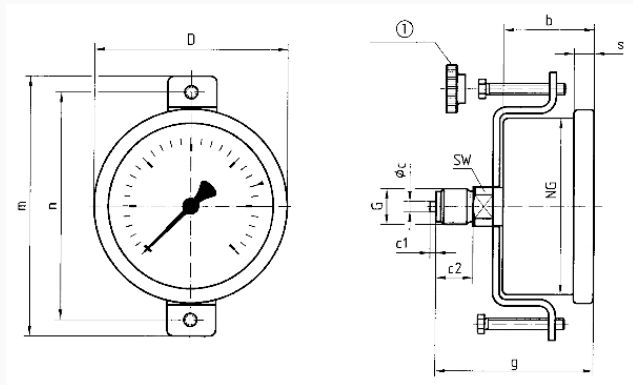

**Dimensions (mm)**

NG	b	∅c	c1	c2	D	G	g	m	n	s	SW
50	31,5	5	2	13	53	G <sup>1</sup> / <sub>4</sub> B	54,5	82	73	5	14
63	32	5	2	13	68	G <sup>1</sup> / <sub>4</sub> B	55	94	82	7	14

**Versions**

Range	Mounting type	Type	Part number
0/160 bar	clamp fixing	RF50Gly D641	85071641

- in-stock items
- Non-stock items