



Glycerine filled Bourdon tube pressure gauges RF50Gly

Part no. 85069701

Glycerine filled Bourdon tube pressure gauges Type D7

benefits

- robust stainless steel housing
- can be used in case of heavy vibrations and high, dynamic pressure loads
- longer service life due to less wear and corrosion protection of the measuring system
- No steaming up of the inside of the window in case of outdoor applications

Application

For gaseous and liquid media which are not highly viscous, do not crystallise and do not attack copper alloys. For measurements in areas with high vibration levels and high, dynamic pressure loads.

Technical Specifications

Type
D7

Nominal size
50

accuracy class (EN 837-1/6)
1.6

ranges (EN 837-1/5)
see ordering table

application area
static load: $\frac{3}{4}$ x full scale value
dynamic load: $\frac{2}{3}$ x full scale value
short-term: Full scale value

Operating temperature range
Medium: max. 60 °C
Ambient: -20/+60 °C

Degree of protection
IP 65 (EN 60529)

Connection
Brass, bottom

Measuring element
Bourdon tube
≤ 60 bar: "C" type tube
> 60 bar: helical tube

movement
Brass

Dial
Aluminium, white
Scaling: black
RF50Gly

Pointer
Aluminium, black

Housing

Stainless steel 304, with blow-out

window

Plastic

crimped bezel

Stainless steel 304

filling liquid

glycerine (99.5 %)

Options

- Filling liquid silicone oil
- Back flange (NG 63/80/100)
- clamp fixing
- 3-hole fixing, panel mounting bezel
- crimped bezel polished
- measuring system stainless steel (up to 1,000 bar, NG 80/100)
- special scales
- Clip reference pointer, red, adjustable (NG 63)
- throttle screw
- other process connections

Technical Drawings

NG 50/63 – bottom connection

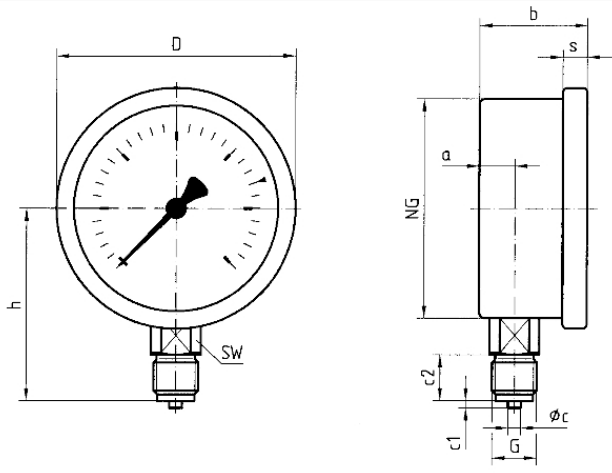

Dimensions (mm)

NG	a	b	∅c	c1	c2	D	G	h	s	SW
50	11	28	5	2	13	53	G¼B	45,5	4,5	14
63	9,5	30,5	5	2	13	68	G¼B	53	7	14

Versions

Range	Mounting type	Type	Part number
0/60 bar	direct	RF50Gly D701	85069701

- in-stock items
- Non-stock items