



Glycerine filled Bourdon tube pressure gauges RF63Gly

Part no. 85104711

Glycerine filled Bourdon tube pressure gauges Type D7

benefits

- robust stainless steel housing
- can be used in case of heavy vibrations and high, dynamic pressure loads
- longer service life due to less wear and corrosion protection of the measuring system
- No steaming up of the inside of the window in case of outdoor applications

Application

For gaseous and liquid media which are not highly viscous, do not crystallise and do not attack copper alloys. For measurements in areas with high vibration levels and high, dynamic pressure loads.

Technical Specifications

Type
D7

Nominal size
63

accuracy class (EN 837-1/6)
1.6

ranges (EN 837-1/5)
see ordering table

application area
static load: $\frac{3}{4}$ x full scale value
dynamic load: $\frac{2}{3}$ x full scale value
short-term: Full scale value

Operating temperature range
Medium: max. 60 °C
Ambient: -20/+60 °C

Degree of protection
IP 54 (EN 60529) with housing vent (≤ 25 bar)

Connection
Brass, centre back

Measuring element
Bourdon tube
 ≤ 60 bar: "C" type tube
 > 60 bar: helical tube

movement
Brass

Dial
Aluminium, white
RF63Gly
dual scale, bar outer, black – psi inner, red

Pointer
Aluminium, black

Housing
Stainless steel 304, with blow-out

crimped bezel
Stainless steel 304

window
Plastic

filling liquid
glycerine (99.5 %)

Options

- Filling liquid silicone oil
- Back flange (NG 63/80/100)
- clamp fixing
- 3-hole fixing, panel mounting bezel
- crimped bezel polished
- measuring system stainless steel (up to 1,000 bar, NG 80/100)
- special scales
- Clip reference pointer, red, adjustable (NG 63)
- throttle screw
- other process connections

Technical Drawings

NG 50/63 – centre back connection

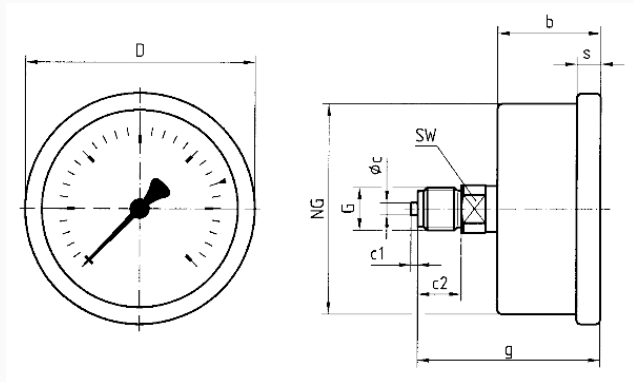

Dimensions (mm)

NG	b	∅c	c1	c2	D	G	g	s	SW
50	28	5	2	13	53	G¼B	51	4,5	14
63	30,5	5	2	13	68	G¼B	53,3	7	14

Versions

Range	Mounting type	Type	Part number
-1/+3 bar	direct	RF63Gly D711	85104711

- in-stock items
- Non-stock items