



## Glycerine filled Bourdon tube pressure gauges RF100Gly

Part no. 85221711

Glycerine filled Bourdon tube pressure gauges Type D7

### benefits

- robust stainless steel housing
- can be used in case of heavy vibrations and high, dynamic pressure loads
- longer service life due to less wear and corrosion protection of the measuring system
- No steaming up of the inside of the window in case of outdoor applications

### Application

For gaseous and liquid media which are not highly viscous, do not crystallise and do not attack copper alloys. For measurements in areas with high vibration levels and high, dynamic pressure loads.

### Technical Specifications

**Type**  
D7

**Nominal size**  
100

**accuracy class (EN 837-1/6)**  
1.6

**ranges (EN 837-1/5)**  
see ordering table

**application area**  
static load:  $\frac{3}{4}$  x full scale value  
dynamic load:  $\frac{2}{3}$  x full scale value  
short-term: Full scale value

**Operating temperature range**  
Medium: max. 60 °C  
Ambient: -20/+60 °C

**Degree of protection**  
IP 65 (EN 60529)

**Connection**  
Brass, centre back

**Measuring element**  
Bourdon tube  
≤ 60 bar: "C" type tube  
> 60 bar: helical tube

**movement**  
Brass

**Dial**  
Aluminium, white  
Scaling: black  
RF100Gly

**Pointer**  
Aluminium, black

**Housing**

Stainless steel 304, with blow-out

**window**

Plastic

**crimped bezel**

Stainless steel 304

**filling liquid**

glycerine (99.5 %)

**Options**

- Filling liquid silicone oil
- Back flange (NG 63/80/100)
- clamp fixing
- 3-hole fixing, panel mounting bezel
- crimped bezel polished
- measuring system stainless steel (up to 1,000 bar, NG 80/100)
- special scales
- Clip reference pointer, red, adjustable (NG 63)
- throttle screw
- other process connections

**Technical Drawings**

**NG 80/100 – centre back connection**

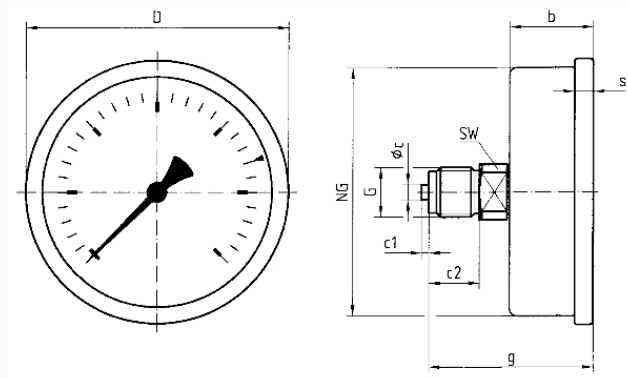

**Dimensions (mm)**

NG	b	∅c	c1	c2	D	g	G	s	SW
80 Ms	33,5	5	2	13	85	56,5	G¼B	7	14
80 VA	33,5	5	2	13	85	59	G¼B	7	14
100 Ms	33,5	6	3	20	106	65,5	G½B	7	22
100 VA	33,5	6	3	20	106	76,5	G½B	7	22

## Versions

Range	Mounting type	Type		Part number
0/160 bar	direct	RF100Gly D711	<input type="radio"/>	85221711

- in-stock items
- Non-stock items