



## Glycerine filled Bourdon tube pressure gauges RF100Gly

Part no. 85203731

Glycerine filled Bourdon tube pressure gauges Type D7

### benefits

- robust stainless steel housing
- can be used in case of heavy vibrations and high, dynamic pressure loads
- longer service life due to less wear and corrosion protection of the measuring system
- No steaming up of the inside of the window in case of outdoor applications

### Application

For gaseous and liquid media which are not highly viscous, do not crystallise and do not attack copper alloys. For measurements in areas with high vibration levels and high, dynamic pressure loads.

### Technical Specifications

**Type**  
D7

**Nominal size**  
100

**accuracy class (EN 837-1/6)**  
1.6

**ranges (EN 837-1/5)**  
see ordering table

**application area**  
static load:  $\frac{3}{4}$  x full scale value  
dynamic load:  $\frac{2}{3}$  x full scale value  
short-term: Full scale value

**Operating temperature range**  
Medium: max. 60 °C  
Ambient: -20/+60 °C

**Degree of protection**  
IP 54 (EN 60529) with housing vent ( $\leq 25$  bar)

**Connection**  
Brass, centre back

**Measuring element**  
Bourdon tube  
 $\leq 60$  bar: "C" type tube  
 $> 60$  bar: helical tube

**movement**  
Brass

**Dial**  
Aluminium, white  
Scaling: black  
RF100Gly

**Pointer**  
Aluminium, black

**Housing**

Stainless steel 304, with blow-out

**window**

Plastic

**crimped bezel**

Stainless steel 304

**filling liquid**

glycerine (99.5 %)

**Options**

- Filling liquid silicone oil
- Back flange (NG 63/80/100)
- clamp fixing
- 3-hole fixing, panel mounting bezel
- crimped bezel polished
- measuring system stainless steel (up to 1,000 bar, NG 80/100)
- special scales
- Clip reference pointer, red, adjustable (NG 63)
- throttle screw
- other process connections

**Technical Drawings**

**NG 100 – centre back connection, 3-hole fixing, panel mounting bezel**

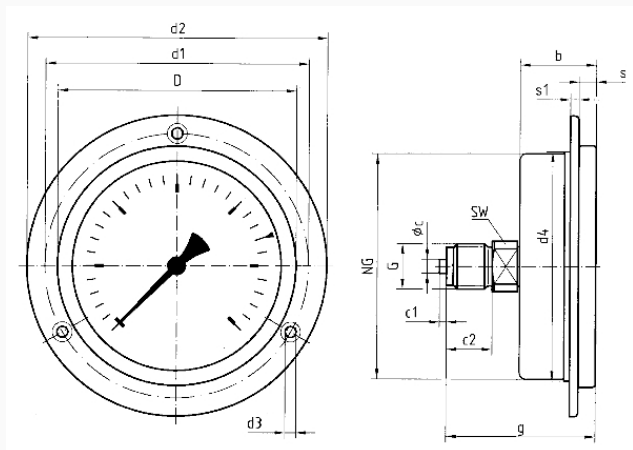

**Dimensions (mm)**

NG	b	∅c	c1	c2	d1*	d2	d3*	d4	D	g	G	s	s1	SW
100	33,5	6	3	20	116	132	4,8	101	106	65,5	G½B	7	3,8	22
Ms														
100	33,5	6	3	20	116	132	4,8	101	106	76,5	G½B	7	3,8	22
VA														

\* Dimensions as per DIN 16064

## Versions

Range	Mounting type	Type		Part number
-1/+1.5 bar	3-hole fixing, panel mounting bezel	RF100Gly D731	●	85203731

- in-stock items
- Non-stock items