



Glycerine filled Bourdon tube pressure gauges RF100Gly

Part no. 85204731

Glycerine filled Bourdon tube pressure gauges Type D7

benefits

- robust stainless steel housing
- can be used in case of heavy vibrations and high, dynamic pressure loads
- longer service life due to less wear and corrosion protection of the measuring system
- No steaming up of the inside of the window in case of outdoor applications

Application

For gaseous and liquid media which are not highly viscous, do not crystallise and do not attack copper alloys. For measurements in areas with high vibration levels and high, dynamic pressure loads.

Technical Specifications

Type
D7

Nominal size
100

accuracy class (EN 837-1/6)
1.6

ranges (EN 837-1/5)
see ordering table

application area
static load: $\frac{3}{4}$ x full scale value
dynamic load: $\frac{2}{3}$ x full scale value
short-term: Full scale value

Operating temperature range
Medium: max. 60 °C
Ambient: -20/+60 °C

Degree of protection
IP 54 (EN 60529) with housing vent (≤ 25 bar)

Connection
Brass, centre back

Measuring element
Bourdon tube
 ≤ 60 bar: "C" type tube
 > 60 bar: helical tube

movement
Brass

Dial
Aluminium, white
Scaling: black
RF100Gly

Pointer
Aluminium, black

Housing

Stainless steel 304, with blow-out

window

Plastic

crimped bezel

Stainless steel 304

filling liquid

glycerine (99.5 %)

Options

- Filling liquid silicone oil
- Back flange (NG 63/80/100)
- clamp fixing
- 3-hole fixing, panel mounting bezel
- crimped bezel polished
- measuring system stainless steel (up to 1,000 bar, NG 80/100)
- special scales
- Clip reference pointer, red, adjustable (NG 63)
- throttle screw
- other process connections

Technical Drawings

NG 100 – centre back connection, 3-hole fixing, panel mounting bezel

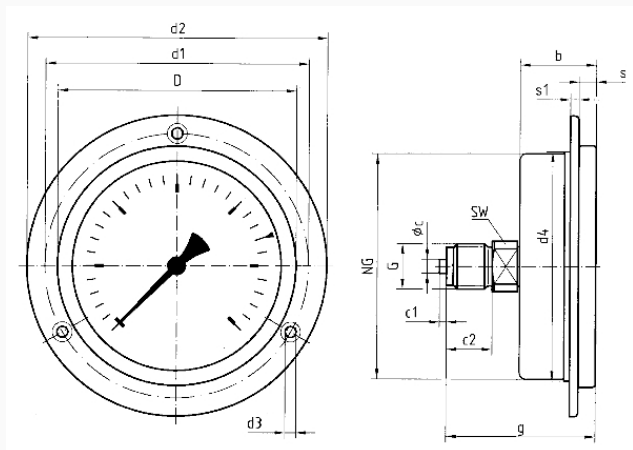

Dimensions (mm)

NG	b	∅c	c1	c2	d1*	d2	d3*	d4	D	g	G	s	s1	SW
100	33,5	6	3	20	116	132	4,8	101	106	65,5	G½B	7	3,8	22
Ms														
100	33,5	6	3	20	116	132	4,8	101	106	76,5	G½B	7	3,8	22
VA														

* Dimensions as per DIN 16064

Versions

Range	Mounting type	Type		Part number
-1/+3 bar	3-hole fixing, panel mounting bezel	RF100Gly D731	●	85204731

- in-stock items
- Non-stock items