

Glycerine filled Bourdon tube pressure gauges RF100Gly

Part no. 85221801

Glycerine filled Bourdon tube pressure gauges Type D8

benefits

- compact design
- can be used in case of heavy vibrations and high, dynamic pressure loads
- longer service life due to less wear and corrosion protection of the measuring system
- No steaming up of the inside of the window in case of outdoor applications

Application

For gaseous and liquid media which are not highly viscous, do not crystallise and do not attack copper alloys. For measurements in areas with high vibration levels and high, dynamic pressure loads.

Technical Specifications

Type
D8

Nominal size
100

accuracy class (EN 837-1/6)
1.0

ranges (EN 837-1/5)
see ordering table

application area
 ≤ 600 bar: Full scale value
 > 600 bar: ¾ x full scale value
 ≤ 600 bar: 0.9 x full scale value
 > 600 bar: ⅔ x full scale value
 ≤ 600 bar: 1.3 x full scale value
 > 600 bar: Full scale value

Operating temperature range

Medium: max. 60 °C
 Ambient: -20/+60 °C

Degree of protection
 IP 65 (EN 60529)

Connection
 Brass, bottom

Measuring element
 Bourdon tube
 ≤ 60 bar: "C" type tube, Copper alloy
 > 60 bar: helical tube, stainless steel 316 Ti/316 L

movement
 Brass

Dial
 Aluminium, white
 Scaling: black

Pointer

Aluminium, black

window

Instrument glass

Housing

Stainless steel 304, with blow-out

filling liquid

glycerine (99.5 %)

bayonet bezel

Stainless steel 304

Options

- back flange
- 3-hole fixing, panel mounting bezel
- 3-hole fixing, panel mounting bezel (NG 63)
- special scales
- other process connections

Technical Drawings

Centre back connection

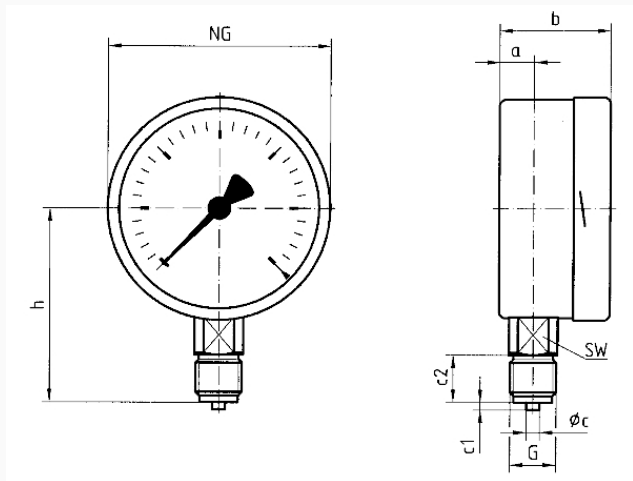

Dimensions (mm)

NG	a	b	Øc	c1	c2	G	h	SW
100	15,6	49	6	3	20	G½B	86	22
160	17,5	50	6	3	20	G½B	116	22

Versions

Range	Mounting type	Type	Part number
0/160 bar	direct	RF100Gly D801	85221801

- in-stock items
- Non-stock items