



## Glycerine filled Bourdon tube pressure gauges RF100Gly

Part no. 85218811

Glycerine filled Bourdon tube pressure gauges Type D8

### benefits

- compact design
- can be used in case of heavy vibrations and high, dynamic pressure loads
- longer service life due to less wear and corrosion protection of the measuring system
- No steaming up of the inside of the window in case of outdoor applications

### Application

For gaseous and liquid media which are not highly viscous, do not crystallise and do not attack copper alloys. For measurements in areas with high vibration levels and high, dynamic pressure loads.

### Technical Specifications

**Type**  
D8

**Nominal size**  
100

**accuracy class (EN 837-1/6)**  
1.0

**ranges (EN 837-1/5)**  
see ordering table

#### application area

≤ 600 bar: Full scale value  
 > 600 bar: ¼ x full scale value  
 ≤ 600 bar: 0.9 x full scale value  
 > 600 bar: ⅔ x full scale value  
 ≤ 600 bar: 1.3 x full scale value  
 > 600 bar: Full scale value

#### Operating temperature range

Medium: max. 60 °C  
 Ambient: -20/+60 °C

#### Degree of protection

IP 65 (EN 60529)

#### Connection

Brass, bottom back

#### Measuring element

Bourdon tube  
 ≤ 60 bar: "C" type tube, Copper alloy  
 > 60 bar: helical tube, stainless steel 316 Ti/316 L

#### movement

Brass

#### Dial

Aluminium, white  
 Scaling: black

**Pointer**

Aluminium, black

**window**

Instrument glass

**Housing**

Stainless steel 304, with blow-out

**filling liquid**

glycerine (99.5 %)

**bayonet bezel**

Stainless steel 304

**Options**

- back flange
- 3-hole fixing, panel mounting bezel
- 3-hole fixing, panel mounting bezel (NG 63)
- special scales
- other process connections

**Technical Drawings**

**bottom back connection**

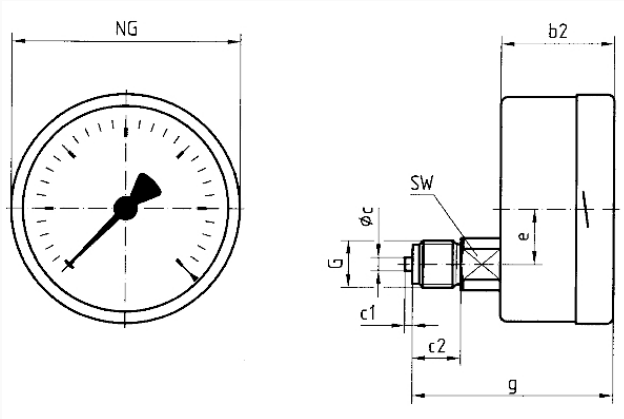

**Dimensions (mm)**

NG	b2	øc	c1	c2	e	G	g	SW
100	49	6	3	20	26,5	G½B	81	22
160	50	6	3	20	26,5	G½B	82	22

**Versions**

Range	Mounting type	Type	Part number
0/40 bar	direct	RF100Gly D811	85218811

- in-stock items
- Non-stock items