



## Glycerine filled Bourdon tube pressure gauges RF100Gly

Part no. 85225831

Glycerine filled Bourdon tube pressure gauges Type D8

### benefits

- compact design
- can be used in case of heavy vibrations and high, dynamic pressure loads
- longer service life due to less wear and corrosion protection of the measuring system
- No steaming up of the inside of the window in case of outdoor applications

### Application

For gaseous and liquid media which are not highly viscous, do not crystallise and do not attack copper alloys. For measurements in areas with high vibration levels and high, dynamic pressure loads.

### Technical Specifications

**Type**  
D8

**Nominal size**  
100

**accuracy class (EN 837-1/6)**  
1.0

**ranges (EN 837-1/5)**  
see ordering table

**application area**  
 ≤ 600 bar: Full scale value  
 > 600 bar: ¾ x full scale value  
 ≤ 600 bar: 0.9 x full scale value  
 > 600 bar: ¾ x full scale value  
 ≤ 600 bar: 1.3 x full scale value  
 > 600 bar: Full scale value

**Operating temperature range**  
 Medium: max. 60 °C  
 Ambient: -20/+60 °C

**Degree of protection**  
IP 65 (EN 60529)

**Connection**  
Brass, bottom back

**Measuring element**  
 Bourdon tube  
 ≤ 60 bar: "C" type tube, Copper alloy  
 > 60 bar: helical tube, stainless steel 316 Ti/316 L

**movement**  
Brass

**Dial**  
Aluminium, white  
Scaling: black

**Pointer**  
Aluminium, black

**Housing**  
Stainless steel 304, with blow-out

**bayonet bezel**  
Stainless steel 304

**window**  
Instrument glass

**filling liquid**  
glycerine (99.5 %)

**Options**

- back flange
- 3-hole fixing, panel mounting bezel
- 3-hole fixing, panel mounting bezel (NG 63)
- special scales
- other process connections

**Technical Drawings**

**bottom back connection, 3-hole fixing, panel mounting bezel**

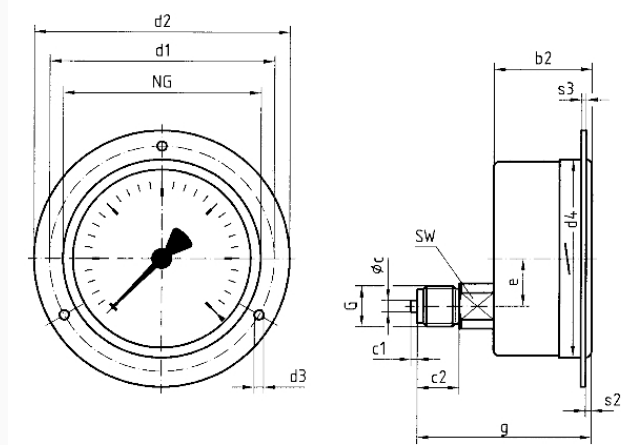

**Dimensions (mm)**

NG	b2	∅c	c1	c2	d1*	d2	d3*	d4	e	G	g	s2	s3	SW
100	49	6	3	20	116	132	4,8	104	26,5	G½B	81	4	2	22
160	50	6	3	20	178	196	5,8	164	26,5	G½B	82	4	2	22

\* Dimensions as per DIN 16064

**Versions**

Range	Mounting type	Type	Part number
0/1000 bar	3-hole fixing, panel mounting bezel	RF100Gly D831	85225831

- in-stock items
- Non-stock items