



Glycerine filled Bourdon tube pressure gauges RF160Gly

Part no. 85259831

Glycerine filled Bourdon tube pressure gauges Type D8

benefits

- compact design
- can be used in case of heavy vibrations and high, dynamic pressure loads
- longer service life due to less wear and corrosion protection of the measuring system
- No steaming up of the inside of the window in case of outdoor applications

Application

For gaseous and liquid media which are not highly viscous, do not crystallise and do not attack copper alloys. For measurements in areas with high vibration levels and high, dynamic pressure loads.

Technical Specifications

Type
D8

Nominal size
160

accuracy class (EN 837-1/6)
1.0

ranges (EN 837-1/5)
see ordering table

application area
 ≤ 600 bar: Full scale value
 > 600 bar: ¾ x full scale value
 ≤ 600 bar: 0.9 x full scale value
 > 600 bar: ¾ x full scale value
 ≤ 600 bar: 1.3 x full scale value
 > 600 bar: Full scale value

Operating temperature range
 Medium: max. 60 °C
 Ambient: -20/+60 °C

Degree of protection

IP 54 (EN 60529) with housing vent (≤ 25 bar)

Connection

Brass, bottom back

Measuring element

Bourdon tube
 ≤ 60 bar: "C" type tube, Copper alloy
 > 60 bar: helical tube, stainless steel 316 Ti/316 L

movement

Brass

Dial

Aluminium, white
 Scaling: black

Pointer

Aluminium, black

Housing

Stainless steel 304, with blow-out

bayonet bezel

Stainless steel 304

window
Instrument glass

filling liquid
glycerine (99.5 %)

Options

- back flange
- 3-hole fixing, panel mounting bezel
- 3-hole fixing, panel mounting bezel (NG 63)
- special scales
- other process connections

Technical Drawings

bottom back connection, 3-hole fixing, panel mounting bezel

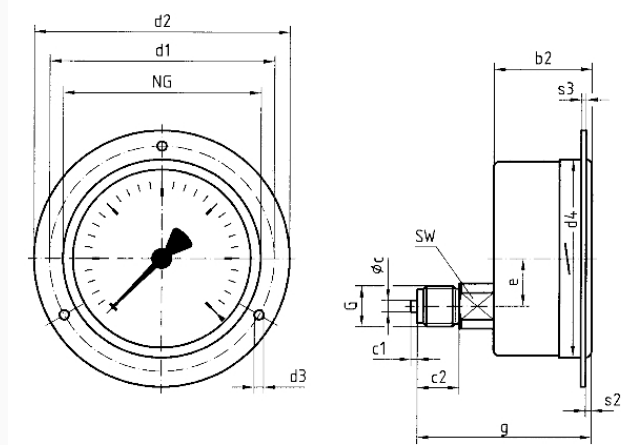

Dimensions (mm)

NG	b2	∅c	c1	c2	d1*	d2	d3*	d4	e	G	g	s2	s3	SW
100	49	6	3	20	116	132	4,8	104	26,5	G½B	81	4	2	22
160	50	6	3	20	178	196	5,8	164	26,5	G½B	82	4	2	22

* Dimensions as per DIN 16064

Versions

Range	Mounting type	Type	Part number
0/0.6 bar	3-hole fixing, panel mounting bezel	RF160Gly D831	85259831

- in-stock items
- Non-stock items