

Bourdon tube pressure gauges for chemical applications RF50ChGly

Part no. 85067712

Bourdon tube pressure gauges for chemical applications Type D7 with glycerine filling

benefits

- for chemical and process engineering applications
- measuring system fully welded to housing
- extremely robust design
- can be used in case of heavy vibrations and high, dynamic pressure loads
- tightness-tested with helium
- DNV- and GOSSTANDART-certified
- Ex version (optional)

Application

For corrosive gaseous and liquid media which are not highly viscous and do not crystallise; suitable for corrosive environments. For measurements in areas with high vibration levels and high, dynamic pressure loads.

! For measuring gas or vapour, observe the table "Selection Criteria as per EN 837-2" (see appendix)!

Technical Specifications

Type
D7

Nominal size
50

accuracy class (EN 837-1/6)
1.6

ranges (EN 837-1/5)
see ordering table

application area
static load: $\frac{3}{4}$ x full scale value
dynamic load: $\frac{2}{3}$ x full scale value
short-term: Full scale value

Operating temperature range
Medium: max. 100 °C
Ambient: -20/+60 °C

Temperature performance

Indication error when the temperature of the measuring system deviates from the normal temperature of 20 °C:
at rising temperature approx. $\pm 0.4 \%$ /10 K
falling temperature approx. $\pm 0.4 \%$ /10 K
of full scale value

Degree of protection
IP 65 (EN 60529)

Connection
Stainless steel 316 L, bottom back

Measuring element
Bourdon tube, stainless steel 316 Ti/316 L
 ≤ 60 bar: "C" type tube
> 60 bar: helical tube
tightness-tested with helium

movement
Stainless steel

Dial
Aluminium, white
Scaling: black

Pointer
Aluminium, black

Housing
Stainless steel 304, with blow-out

bayonet bezel
NG 50

crimped bezel
Stainless steel 304

window
NG 50
Plastic

filling liquid
glycerine (99.5 %)

Options

- Filling liquid silicone oil
- plastic window (NG 63)
- Back flange (NG 63)
- clamp fixing
- Ex version
- Crimped bezel, polished
- special scales
- other process connections

Technical Drawings

NG 50 – bottom back connection

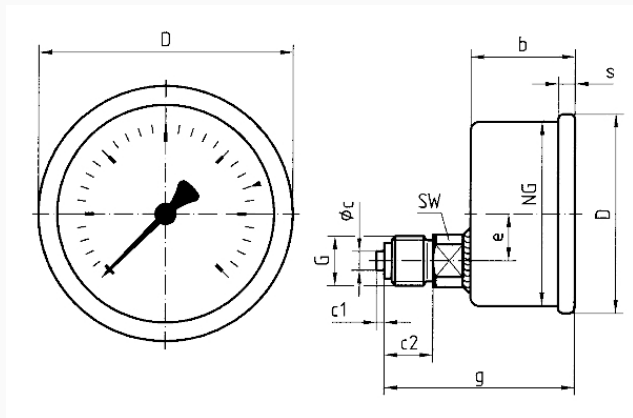

Dimensions (mm)

NG	b	∅c	c1	c2	D	e	G	g	s	SW
50	28	5	2	13	53	12,5	G¼B	51	4,5	14

Versions

Range	Mounting type	Type		Part number
0/25 bar	direct	RF50ChGly D712	●	85067712

- in-stock items
- Non-stock items