

## Bourdon tube pressure gauges for chemical applications RF50ChGly

Part no. 85067752

Bourdon tube pressure gauges for chemical applications Type D7 with glycerine filling

### benefits

- for chemical and process engineering applications
- measuring system fully welded to housing
- extremely robust design
- can be used in case of heavy vibrations and high, dynamic pressure loads
- tightness-tested with helium
- DNV- and GOSSTANDART-certified
- Ex version (optional)

### Application

For corrosive gaseous and liquid media which are not highly viscous and do not crystallise; suitable for corrosive environments. For measurements in areas with high vibration levels and high, dynamic pressure loads.

! For measuring gas or vapour, observe the table "Selection Criteria as per EN 837-2" (see appendix)!

### Technical Specifications

**Type**  
D7

**Nominal size**  
50

**accuracy class (EN 837-1/6)**  
1.6

**ranges (EN 837-1/5)**  
see ordering table

**application area**  
static load:  $\frac{3}{4}$  x full scale value  
dynamic load:  $\frac{2}{3}$  x full scale value  
short-term: Full scale value

**Operating temperature range**  
Medium: max. 100 °C  
Ambient: -20/+60 °C

### Temperature performance

Indication error when the temperature of the measuring system deviates from the normal temperature of 20 °C:  
at rising temperature approx.  $\pm 0.4$  %/10 K  
falling temperature approx.  $\pm 0.4$  %/10 K  
of full scale value

**Degree of protection**  
IP 65 (EN 60529)

**Connection**  
Stainless steel 316 L, bottom back

**Measuring element**  
Bourdon tube, stainless steel 316 Ti/316 L  
 $\leq 60$  bar: "C" type tube  
> 60 bar: helical tube  
tightness-tested with helium

**movement**  
Stainless steel

**Dial**  
Aluminium, white  
Scaling: black

**Pointer**  
Aluminium, black

**Housing**  
Stainless steel 304, with blow-out

**bayonet bezel**  
NG 50

**crimped bezel**  
Stainless steel 304

**window**  
NG 50  
Plastic

**filling liquid**  
glycerine (99.5 %)

**Options**

- Filling liquid silicone oil
- plastic window (NG 63)
- Back flange (NG 63)
- clamp fixing
- Ex version
- Crimped bezel, polished
- special scales
- other process connections

**Technical Drawings**

**NG 50 – bottom back connection, with clamp fixing**

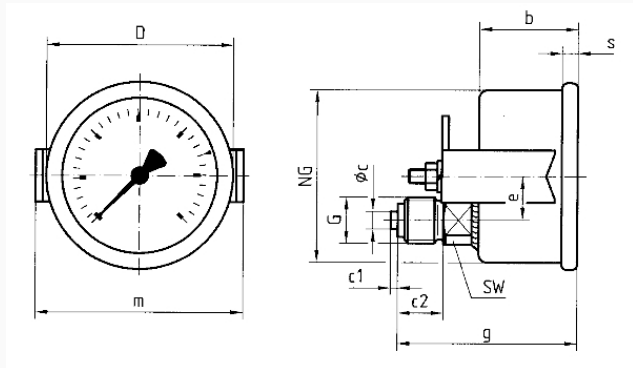

**Dimensions (mm)**

NG	b	∅c	c1	c2	D	e	G	g	m	s	SW
50	28	5	2	13	53	12,5	G¼B	51	59	4,5	14

## Versions

Range	Mounting type	Type		Part number
0/25 bar	clamp fixing	RF50ChGly D752	●	85067752

- in-stock items
- Non-stock items