



## Bourdon tube pressure gauges for chemical applications RF100ChGly

Part no. 85219802

Bourdon tube pressure gauges for chemical applications Type D8 with glycerine filling

### benefits

- for chemical and process engineering applications
- measuring system fully welded to housing
- extremely robust design
- can be used in case of heavy vibrations and high, dynamic pressure loads
- tightness-tested with helium
- DNV- and GOSSTANDART-certified
- Ex version (optional)

### Application

For corrosive gaseous and liquid media which are not highly viscous and do not crystallise; suitable for corrosive environments. For measurements in areas with high vibration levels and high, dynamic pressure loads.

! For measuring gas or vapour, observe the table "Selection Criteria as per EN 837-2" (see appendix)!

### Technical Specifications

**Type**  
D8

**Nominal size**  
100

**accuracy class (EN 837-1/6)**  
1.0

**ranges (EN 837-1/5)**  
see ordering table

**application area**  
 ≤ 600 bar: Full scale value  
 > 600 bar: ¼ x full scale value  
 ≤ 600 bar: 0.9 x full scale value  
 > 600 bar: ⅔ x full scale value  
 ≤ 600 bar: 1.3 x full scale value  
 > 600 bar: Full scale value

### Operating temperature range

Medium: max. 100 °C  
 Ambient: -20/+60 °C

### Temperature performance

Indication error when the temperature of the measuring system deviates from the normal temperature of 20 °C:  
 at rising temperature approx. ± 0.4 %/10 K  
 falling temperature approx. ± 0.4 %/10 K  
 of full scale value

### Degree of protection

IP 65 (EN 60529)

### Connection

stainless steel 316 Ti/316 L, bottom

**Measuring element**

Bourdon tube, stainless steel 316 Ti/316 L  
 ≤ 60 bar: "C" type tube  
 > 60 bar: helical tube  
 tightness-tested with helium

**movement**

Stainless steel

**Dial**

Aluminium, white  
 Scaling: black

**Pointer**

Aluminium, black

**Housing**

Stainless steel 304, with blow-out

**bayonet bezel**

Stainless steel 304

**window**

Laminated safety glass

**filling liquid**

glycerine (99.5 %)

**Options**

- Filling liquid silicone oil
- Brass movement
- back flange
- 3-hole fixing, panel mounting bezel
- Ex version
- Electrical contacts
- special scales
- other process connections

**Technical Drawings**

**Bottom connection**

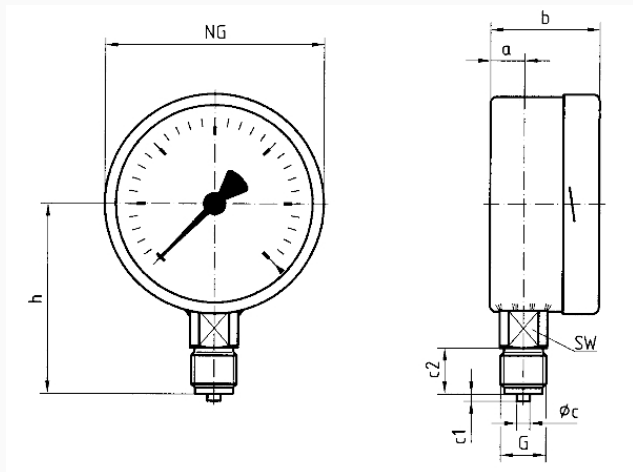

**Dimensions (mm)**

NG	a	b	Øc	c1	c2	G	h	SW
100	15,6	49	6	3	20	G½B	86	22
160	17,5	50	6	3	20	G½B	116	22

## Versions

Range	Mounting type	Type		Part number
0/60 bar	direct	RF100ChGly D802	<input checked="" type="radio"/>	85219802

- in-stock items
- Non-stock items