



## Bourdon tube pressure gauges for chemical applications RF160ChGly

Part no. 85275832

Bourdon tube pressure gauges for chemical applications Type D8 with glycerine filling

### benefits

- for chemical and process engineering applications
- measuring system fully welded to housing
- extremely robust design
- can be used in case of heavy vibrations and high, dynamic pressure loads
- tightness-tested with helium
- DNV- and GOSSTANDART-certified
- Ex version (optional)

### Application

For corrosive gaseous and liquid media which are not highly viscous and do not crystallise; suitable for corrosive environments. For measurements in areas with high vibration levels and high, dynamic pressure loads.

! For measuring gas or vapour, observe the table "Selection Criteria as per EN 837-2" (see appendix)!

### Technical Specifications

**Type**  
D8

**Nominal size**  
160

**accuracy class (EN 837-1/6)**  
1.0

**ranges (EN 837-1/5)**  
see ordering table

**application area**  
 $\leq 600$  bar: Full scale value  
 $> 600$  bar:  $\frac{3}{4}$  x full scale value  
 $\leq 600$  bar: 0.9 x full scale value  
 $> 600$  bar:  $\frac{2}{3}$  x full scale value  
 $\leq 600$  bar: 1.3 x full scale value  
 $> 600$  bar: Full scale value

### Operating temperature range

Medium: max. 100 °C  
Ambient: -20/+60 °C

### Temperature performance

Indication error when the temperature of the measuring system deviates from the normal temperature of 20 °C:  
 at rising temperature approx.  $\pm 0.4$  %/10 K  
 falling temperature approx.  $\pm 0.4$  %/10 K  
 of full scale value

### Degree of protection

IP 65 (EN 60529)

### Connection

stainless steel 316 Ti/316 L, bottom back

**Measuring element**

Bourdon tube, stainless steel 316 Ti/316 L  
 ≤ 60 bar: "C" type tube  
 > 60 bar: helical tube  
 tightness-tested with helium

**movement**

Stainless steel

**Dial**

Aluminium, white  
 Scaling: black

**Pointer**

Aluminium, black

**Housing**

Stainless steel 304, with blow-out

**bayonet bezel**

Stainless steel 304

**window**

Laminated safety glass

**filling liquid**

glycerine (99.5 %)

**Options**

- Filling liquid silicone oil
- Brass movement
- back flange
- 3-hole fixing, panel mounting bezel
- Ex version
- Electrical contacts
- special scales
- other process connections

**Technical Drawings**

bottom back connection, 3-hole fixing, panel mounting bezel

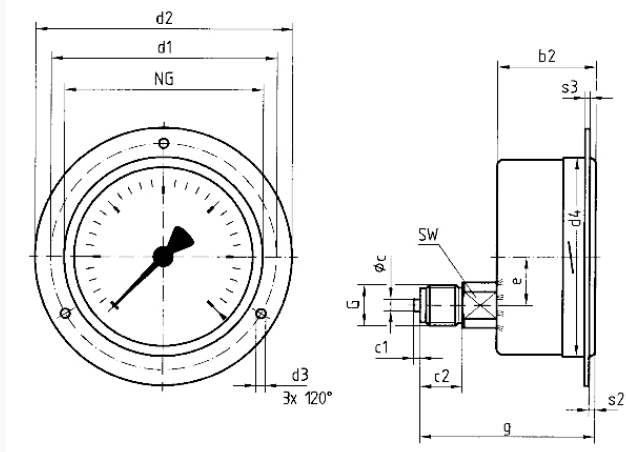

**Dimensions (mm)**

NG	b2	∅c	c1	c2	d1	d2	d3	d4	e	G	g	s2	s3	SW
100	49	6	3	20	116*132*4,8*	104	34,5G½B	83	4	2	22			
160	50	6	3	20	178	196	5,8	164	34,5G½B	84	4	2	22	

\* Dimensions as per DIN 16064

## Versions

Range	Mounting type	Type		Part number
0/1000 bar	3-hole fixing, panel mounting bezel	RF160ChGly D832	●	85275832

- in-stock items
- Non-stock items