



Bourdon tube pressure gauge RF80KTGly

Part no. 85183711

Standard Bourdon tube pressure gauges for refrigeration engineering type D7 with glycerine filling

benefits

- can be used in case of heavy vibrations and high, dynamic pressure loads
- longer service life due to less wear and corrosion protection of the measuring system
- various refrigerants measurable with multiple scales
- DNV- and GOSSTANDART-certified

Application

For simultaneous measurement of vapour pressures and temperatures in refrigeration engineering.
! For measuring gas or vapour, observe the table "Selection Criteria as per EN 837-2" (see appendix)!

Technical Specifications

Type
D7

Nominal size
80

accuracy class
EN 837-1/6
NG 80
1.0

ranges
-1/+24 bar

temperature scales
for cooling agent: R 134a,
R 290,
R 404A,
R 407A,
R 507,
R 744

application area

static load: $\frac{3}{4}$ x full scale value
dynamic load: $\frac{2}{3}$ x full scale value
short-term: Full scale value

Operating temperature range

Medium: according to cooling agent
Ambient: -20/+60 °C

Temperature performance

Indication error when the temperature of the measuring system deviates from the normal temperature of 20 °C:
at rising temperature approx. ± 0.4 %/10 K
falling temperature approx. ± 0.4 %/10 K
of full scale value

Degree of protection

IP 54 (EN 60529) with housing vent (≤ 25 bar)

Connection

Brass, centre back
7/16-20 UNF

Measuring element

Bourdon tube, Copper alloy
"C" type tube

movement
Brass

Dial
Aluminium, white
pressure dial marking: black
temperature dial marking: coloured

Pointer
Aluminium, black

Housing
Stainless steel 304, with blow-out

crimped bezel
Stainless steel 304

window
Plastic

filling liquid
glycerine (99.5 %)

Options

- Temperature scales for other refrigerants
- back flange
- clamp fixing
- 3-hole fixing, panel mounting bezel (NG 63/100)
- throttle screw
- special scales
- other process connections
- 7/16 – 20 UNF SAE J513 (45°)

Technical Drawings

Centre back connection

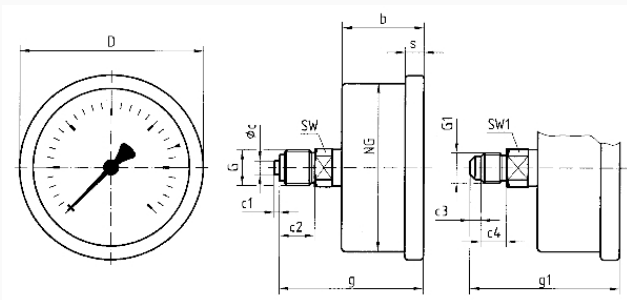

Dimensions (mm)

NG	b	∅c	c1	c2	c3	c4	D	g	g1	G	G1	s	SWSW1
63	30,5	5	2	13	4	9,5	68	53,5	55,5	5G1/8	B16-207	14	14
											UNF		
80	33,5	6	3	20	4	9,5	85	65,5	58,5	5G1/8	B16-207	22	14
											UNF		
100	33,5	6	3	20	4	9,5	106	65,5	58,5	5G1/8	B16-207	22	14
											UNF		

Versions

Range	Mounting type	Type		Part number
-1/+24 bar	direct	RF80KTGly D711	<input type="radio"/>	85183711

- in-stock items
- Non-stock items