



Bourdon tube safety pressure gauges RF63SiGly

Part no. 85415802

Bourdon tube safety pressure gauges Type D8 with glycerine filling

benefits

- Safety housing S3 as per EN 837-1/9.7.2
- measuring system fully welded to housing
- tightness-tested with helium
- DNV- and GOSSTANDART-certified
- Ex version (optional)

Application

For corrosive gaseous and liquid media which are not highly viscous and do not crystallise; suitable for corrosive environments. This gauge is designed for applications as per EN 837-1/9.7.2.

Technical Specifications

Type
D8

Nominal size
63

accuracy class
EN 837-1/6
NG 63, ≤ 400 bar
1.6

ranges (EN 837-1/5)
see ordering table

Operating temperature range
Medium: max. 100 °C
Ambient: -20/+60 °C

Degree of protection
IP 54 (EN 60529)

Connection

Stainless steel 316 L, bottom

Measuring element

Bourdon tube, Stainless steel 316 L
tightness-tested with helium

movement

Stainless steel

Dial

Aluminium, white
Scaling: black

Pointer

Aluminium, black

Housing

Stainless steel 304, with solid baffle wall and blow-out (S3)

bayonet bezel

Stainless steel 304

window
Laminated safety glass

filling liquid
glycerine (99.5 %)

Technical Drawings

NG 63 – bottom connection

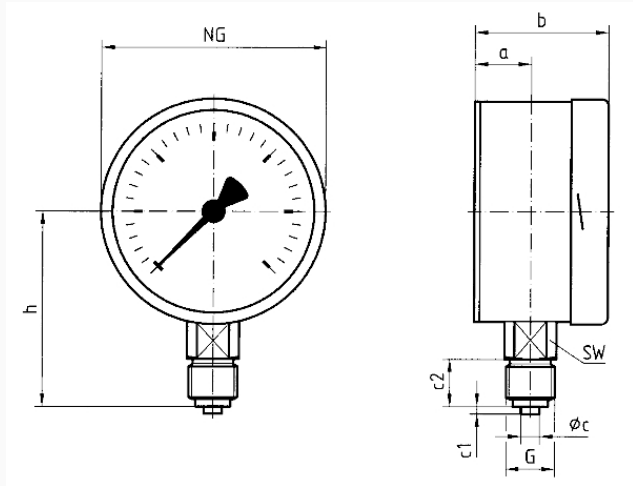

Dimensions (mm)

NG	a	b	∅c	c1	c2	G	h	SW
63	18	41	5	2	13	G¼B	53	14

Versions

Range	Mounting type	Type	Part number
0/10 bar	direct	RF63SiGly D802	85415802

- in-stock items
- Non-stock items