



## Bourdon tube safety pressure gauges RF63SiGly

**Part no. 85419802**

**Bourdon tube safety pressure gauges Type D8 with glycerine filling**

### benefits

- Safety housing S3 as per EN 837-1/9.7.2
- measuring system fully welded to housing
- tightness-tested with helium
- DNV- and GOSSTANDART-certified
- Ex version (optional)

### Application

For corrosive gaseous and liquid media which are not highly viscous and do not crystallise; suitable for corrosive environments. This gauge is designed for applications as per EN 837-1/9.7.2.

### Technical Specifications

#### Type

D8

#### Nominal size

63

#### accuracy class

EN 837-1/6

NG 63, ≤ 400 bar

1.6

#### ranges (EN 837-1/5)

see ordering table

#### Operating temperature range

Medium: max. 100 °C

Ambient: -20/+60 °C

#### Degree of protection

IP 54 (EN 60529)

#### Connection

Stainless steel 316 L, bottom

#### Measuring element

Bourdon tube, Stainless steel 316 L  
tightness-tested with helium

#### movement

Stainless steel

#### Dial

Aluminium, white

Scaling: black

#### Pointer

Aluminium, black

#### Housing

Stainless steel 304, with solid baffle wall and blow-out (S3)

#### bayonet bezel

Stainless steel 304

**window**  
Laminated safety glass

**filling liquid**  
glycerine (99.5 %)

**Technical Drawings**

**NG 63 – bottom connection**

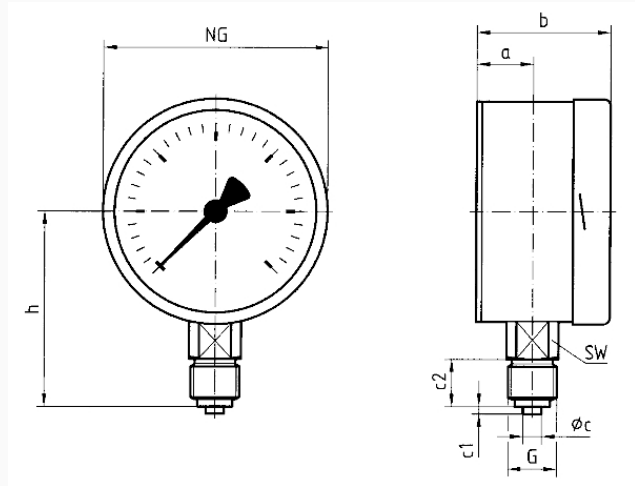

**Dimensions (mm)**

NG	a	b	Øc	c1	c2	G	h	SW
63	18	41	5	2	13	G¼B	53	14

**Versions**

Range	Mounting type	Type	Part number
0/60 bar	direct	RF63SiGly D802	85419802

- in-stock items
- Non-stock items