



Bourdon tube safety pressure gauges RF160SiGly

Part no. 85502802

Bourdon tube safety pressure gauges Type D8 with glycerine filling

benefits

- Safety housing S3 as per EN 837-1/9.7.2
- measuring system fully welded to housing
- tightness-tested with helium
- DNV- and GOSSTANDART-certified
- Ex version (optional)

Application

For corrosive gaseous and liquid media which are not highly viscous and do not crystallise; suitable for corrosive environments. This gauge is designed for applications as per EN 837-1/9.7.2.

Technical Specifications

Type
D8

Nominal size
160

accuracy class
EN 837-1/6
NG 160
1.0

ranges (EN 837-1/5)
see ordering table

application area
 ≤ 600 bar: Full scale value
 > 600 bar: ¼ x full scale value
 ≤ 600 bar: 0.9 x full scale value
 > 600 bar: ⅔ x full scale value
 ≤ 600 bar: 1.3 x full scale value
 > 600 bar: Full scale value

Operating temperature range

Medium: max. 100 °C
Ambient: -20/+60 °C

Degree of protection

IP 54 (EN 60529)

Connection

Stainless steel 316 L, bottom

Measuring element

Bourdon tube, Stainless steel 316 L
tightness-tested with helium

movement

Stainless steel

Dial

Aluminium, white
Scaling: black

Pointer

Aluminium, black

window

Laminated safety glass

Housing

Stainless steel 304, with solid baffle wall and blow-out (S3)

filling liquid

glycerine (99.5 %)

bayonet bezel

Stainless steel 304

Technical Drawings

NG 100/160 – bottom connection

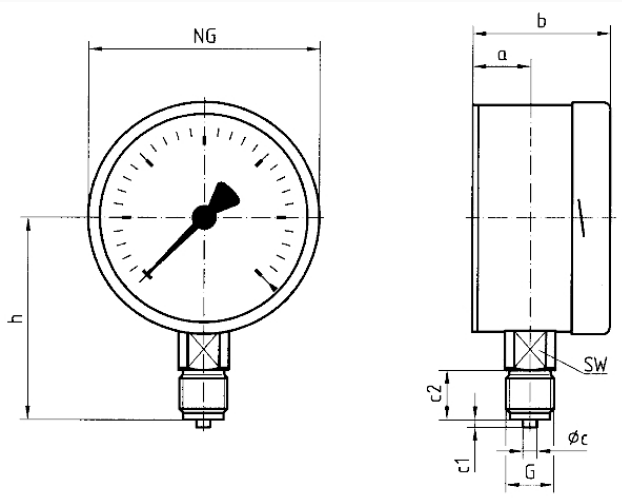

Dimensions (mm)

NG	a	b	Øc	c1	c2	G	h	SW
100	27	60	6	3	20	G½B	86	22
160	40	78	6	3	20	G½B	118	22

Versions

Range	Mounting type	Type	Part number
-1/+0.6 bar	direct	RF160SiGly D802	85502802

- in-stock items
- Non-stock items