



Standard Bourdon tube pressure gauges RF63 IK2

Part no. 87574302

Bourdon tube pressure gauge with electrical contact type D3

benefits

- up to two contacts possible
- wetted parts and movement made of stainless steel
- available with MK, EK, IK
- Safety housing S2 as per EN 837-1 (blow-out)

Application

For corrosive gaseous and liquid media which are not highly viscous and do not crystallise. For measuring in areas with limited space. Especially suitable for monitoring minimum pressure in gas cylinders together with AFRISO alarm unit for low gas level.

Technical Specifications

Type
D3

Nominal size
63

accuracy class (EN 837-1/6)
1.6

ranges (EN 837-1/5)
see ordering table

application area
static load: $\frac{3}{4}$ x full scale value
dynamic load: $\frac{2}{3}$ x full scale value
short-term: Full scale value

contact types
inductive contact (IK)

minimum range
IK dual
1.6 bar

Operating temperature range
Medium: max. 150 °C
Ambient: -20/+60 °C

Temperature performance
Indication error when the temperature of the measuring system deviates from the normal temperature of 20 °C:
at rising temperature approx. $\pm 0.4 \%$ /10 K
falling temperature approx. $\pm 0.4 \%$ /10 K
of full scale value

Degree of protection
IP 42 (EN 60529)

Connection
stainless steel 316 Ti/316 L, bottom
G $\frac{1}{4}$ B, SW14 (EN 837-1/7.3)

Electrical connection

Cable gland M12 x 1.5
Cable 1 m

Measuring element

Bourdon tube, stainless steel 316 Ti/316 L
≤ 60 bar: "C" type tube
> 60 bar: helical tube

movement

Stainless steel

Dial

Aluminium, white
Scaling: black

Pointer

Aluminium, black

Housing

Stainless steel 304, safety housing S2 as per EN 837-1, with rear blow-out

Options

- wetted parts oil-free and grease-free (≤ 0/400 bar)
- Ultra-pure gas version
- back flange
- throttle screw
- special scales
- other process connections

push on bezel

Stainless steel 304

window

Plastic (Makrolon), with contact adjustment lock

Supply voltage

DC 5 – 25 V

Current input

≥ 2.1 mA

Switching accuracy

approx. 0.5 % of full scale value

Operating temperature range

-20/+70 °C or corresponding to the respective measuring instruments

Adjustment range

5–95 % measuring range of gauge

Options

- contact systems with safety integrity level SIL 2

Technical Drawings

Bottom connection

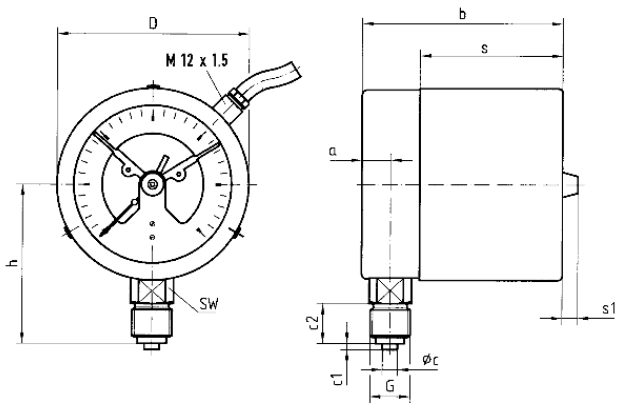

Dimensions (mm)

NG	a	b	Øc	c1	c2	D	G	h	s	s1	SW
63	9,5	66	5	2	13	64	G¼B	46	47,5	8	14

Versions

Range	Mounting type	Type	Part number
0/600 bar	direct	RF63 IK2 D302	87574302

- in-stock items
- Non-stock items