

## Standard Bourdon tube pressure gauges RF63 MK2

Part no. 87513302

Bourdon tube pressure gauge with electrical contact type D3

### benefits

- up to two contacts possible
- wetted parts and movement made of stainless steel
- available with MK, EK, IK
- Safety housing S2 as per EN 837-1 (blow-out)

### Application

For corrosive gaseous and liquid media which are not highly viscous and do not crystallise. For measuring in areas with limited space. Especially suitable for monitoring minimum pressure in gas cylinders together with AFRISO alarm unit for low gas level.

### Technical Specifications

**Type**  
D3

**Nominal size**  
63

**accuracy class (EN 837-1/6)**  
1.6

**ranges (EN 837-1/5)**  
see ordering table

**application area**  
static load:  $\frac{3}{4}$  x full scale value  
dynamic load:  $\frac{2}{3}$  x full scale value  
short-term: Full scale value

**contact types**  
Magnetic spring contact (MK)

**minimum range**  
MK dual  
1.6 bar

**Operating temperature range**  
Medium: max. 150 °C  
Ambient: -20/+60 °C

**Temperature performance**  
Indication error when the temperature of the measuring system deviates from the normal temperature of 20 °C:  
at rising temperature approx.  $\pm 0.4 \%$ /10 K  
falling temperature approx.  $\pm 0.4 \%$ /10 K  
of full scale value

**Degree of protection**  
IP 42 (EN 60529)

**Connection**  
stainless steel 316 Ti/316 L, bottom  
G $\frac{1}{4}$ B, SW14 (EN 837-1/7.3)

**Electrical connection**

Cable gland M12 x 1.5  
Cable 1 m

**Measuring element**

Bourdon tube, stainless steel 316 Ti/316 L  
≤ 60 bar: "C" type tube  
> 60 bar: helical tube

**movement**

Stainless steel

**Dial**

Aluminium, white  
Scaling: black

**Pointer**

Aluminium, black

**Housing**

Stainless steel 304, safety housing S2 as per EN 837-1, with rear blow-out

**push on bezel**

Stainless steel 304

**window**

Plastic (Makrolon), with contact adjustment lock

**Supply voltage**

max. AC/DC 250 V

**Making current and breaking current**

max. 1 A

**Continuous current**

max. 0.6 A

**Switch rating**

max. 50 VA, max. 30 W

**Contact**

Ag80 Ni20 Au 10 µm

**Switching accuracy**

approx. 2–5 % of full scale value

**Operating temperature range**

-20/+70 °C or corresponding to the respective measuring instruments

**Adjustment range**

5–95 % measuring range of gauge

**Options**

- wetted parts oil-free and grease-free (≤ 0/400 bar)
- Ultra-pure gas version
- back flange
- throttle screw
- special scales
- other process connections

**Technical Drawings**

**Bottom connection**

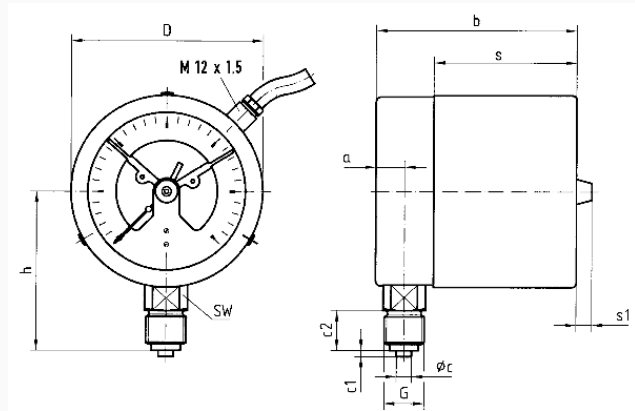

**Dimensions (mm)**

NG	a	b	Øc	c1	c2	D	G	h	s	s1	SW
63	9,5	66	5	2	13	64	G¼B	46	47,5	8	14

**Versions**

Range	Mounting type	Type	Part number
0/4 bar	direct	RF63 MK2 D302	87513302

- in-stock items
- Non-stock items