



## Bourdon tube pressure gauges for chemical applications RF100Ch MK1

Part no. 87618402

Bourdon tube pressure gauges for chemical applications with electrical contact type D4

### benefits

- measuring system fully welded to housing
- robust mechatronic pressure gauge
- Up to four switching contacts
- tightness-tested with helium
- GOSSTANDART-certified

### Application

For corrosive gaseous and liquid media which are not highly viscous and do not crystallise; suitable for corrosive environments.

### Technical Specifications

**Type**  
D4

**Nominal size**  
100

**accuracy class (EN 837-1/6)**  
1.0

**ranges (EN 837-1/5)**  
see ordering table

**application area**  
 ≤ 600 bar: Full scale value  
 > 600 bar: ¾ x full scale value  
 ≤ 600 bar: 0.9 x full scale value  
 > 600 bar: ⅔ x full scale value  
 ≤ 600 bar: 1.3 x full scale value  
 > 600 bar: Full scale value

**contact types**  
Magnetic spring contact (MK)

**minimum range**  
MK Single  
1.6 bar

### Operating temperature range

Medium: max. 150 °C  
Ambient: -20/+60 °C

### Temperature performance

Indication error when the temperature of the measuring system deviates from the normal temperature of 20 °C:  
 at rising temperature approx. ± 0.4 %/10 K  
 falling temperature approx. ± 0.4 %/10 K  
 of full scale value

### Degree of protection

IP 54 (EN 60529)

### Connection

stainless steel 316 Ti/316 L, bottom  
G½B, SW22 (EN 837-1/7.3)

### Electrical connection

Junction box

### Measuring element

Bourdon tube, stainless steel 316 Ti/316 L  
 ≤ 60 bar: "C" type tube  
 > 60 bar: helical tube

### movement

Stainless steel

**Dial**

Aluminium, white  
Scaling: black

**Pointer**

Aluminium, black

**Housing**

Stainless steel 304, with blow-out

**bayonet bezel**

Stainless steel 304

**window**

Plastic (Makrolon), with contact adjustment lock

**Supply voltage**

max. AC/DC 250 V

**Making current and breaking current**

max. 1 A

**Options**

- Liquid filling (silicone oil)
- back flange
- 3-hole fixing, panel mounting bezel
- throttle screw
- Connector
- special scales
- other process connections

**Continuous current**

max. 0.6 A

**Switch rating**

max. 50 VA, max. 30 W

**Contact**

Ag80 Ni20 Au 10 µm

**Switching accuracy**

approx. 2–5 % of full scale value

**Operating temperature range**

-20/+70 °C or corresponding to the respective measuring instruments

**Adjustment range**

5–95 % measuring range of gauge

**Technical Drawings**

**Bottom connection**

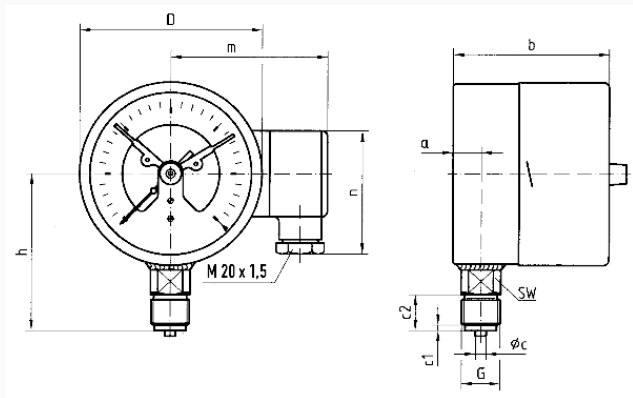

**Dimensions (mm)**

NG	a	b	b1	∅c	c1	c2	D	G	h	m	n	SW
100	15,6	87	90,5	6	3	20	101,5G½B	86	92	72	22	
160	17,5	97	100	6	3	20	161,5G½B	116	122	72	22	

**Versions**

Range	Mounting type	Type	Part number
0/40 bar	direct	RF100Ch MK1 D402	87618402

- in-stock items
- Non-stock items