



Bourdon tube pressure gauges for chemical applications RF100Ch MK2

Part no. 87663402

Bourdon tube pressure gauges for chemical applications with electrical contact type D4

benefits

- measuring system fully welded to housing
- robust mechatronic pressure gauge
- Up to four switching contacts
- tightness-tested with helium
- GOSSTANDART-certified

Application

For corrosive gaseous and liquid media which are not highly viscous and do not crystallise; suitable for corrosive environments.

Technical Specifications

Type
D4

Nominal size
100

accuracy class (EN 837-1/6)
1.0

ranges (EN 837-1/5)
see ordering table

application area
 ≤ 600 bar: Full scale value
 > 600 bar: ¾ x full scale value
 ≤ 600 bar: 0.9 x full scale value
 > 600 bar: ⅔ x full scale value
 ≤ 600 bar: 1.3 x full scale value
 > 600 bar: Full scale value

contact types
Magnetic spring contact (MK)

minimum range
MK dual
1.6 bar

Operating temperature range

Medium: max. 150 °C
Ambient: -20/+60 °C

Temperature performance

Indication error when the temperature of the measuring system deviates from the normal temperature of 20 °C:
 at rising temperature approx. ± 0.4 %/10 K
 falling temperature approx. ± 0.4 %/10 K
 of full scale value

Degree of protection

IP 54 (EN 60529)

Connection

stainless steel 316 Ti/316 L, bottom
G½B, SW22 (EN 837-1/7.3)

Electrical connection

Junction box

Measuring element

Bourdon tube, stainless steel 316 Ti/316 L
 ≤ 60 bar: "C" type tube
 > 60 bar: helical tube

movement

Stainless steel

Dial

Aluminium, white
Scaling: black

Pointer

Aluminium, black

Housing

Stainless steel 304, with blow-out

bayonet bezel

Stainless steel 304

window

Plastic (Makrolon), with contact adjustment lock

Supply voltage

max. AC/DC 250 V

Making current and breaking current

max. 1 A

Options

- Liquid filling (silicone oil)
- back flange
- 3-hole fixing, panel mounting bezel
- throttle screw
- Connector
- special scales
- other process connections

Continuous current

max. 0.6 A

Switch rating

max. 50 VA, max. 30 W

Contact

Ag80 Ni20 Au 10 µm

Switching accuracy

approx. 2–5 % of full scale value

Operating temperature range

-20/+70 °C or corresponding to the respective measuring instruments

Adjustment range

5–95 % measuring range of gauge

Technical Drawings

Bottom connection

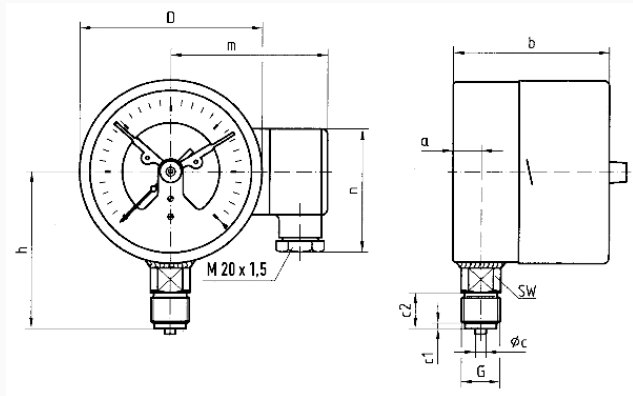

Dimensions (mm)

NG	a	b	b1	∅c	c1	c2	D	G	h	m	n	SW
100	15,6	87	90,5	6	3	20	101,5G½B	86	92	72	22	
160	17,5	97	100	6	3	20	161,5G½B	116	122	72	22	

Versions

Range	Mounting type	Type	Part number
0/4 bar	direct	RF100Ch MK2 D402	87663402

- in-stock items
- Non-stock items