

Bourdon tube pressure gauges for industrial applications RF100I IK1

Part no. 87719401

Bourdon tube pressure gauges for industrial applications with electrical contact type D4



benefits

- robust stainless steel housing
- excellent readability
- Up to four switching contacts
- available with MK, EK, IK

Application

For gaseous and liquid media which are not highly viscous, do not crystallise and do not attack copper alloys.

Technical Specifications

Type
D4

Nominal size
100

accuracy class (EN 837-1/6)
1.0

ranges (EN 837-1/5)
see ordering table

application area
 ≤ 600 bar: Full scale value
 > 600 bar: ¾ x full scale value
 ≤ 600 bar: 0.9 x full scale value
 > 600 bar: ⅘ x full scale value
 ≤ 600 bar: 1.3 x full scale value
 > 600 bar: Full scale value

contact types
inductive contact (IK)

minimum range
IK Single
1 bar

Operating temperature range
Medium: max. 60 °C
Ambient: -20/+60 °C

Temperature performance
Indication error when the temperature of the measuring system deviates from the normal temperature of 20 °C:
at rising temperature approx. ± 0.4 %/10 K
falling temperature approx. ± 0.4 %/10 K
of full scale value

Degree of protection
IP 54 (EN 60529)

Connection
Brass, bottom
G½B, SW22 (EN 837-1/7.3)

Electrical connection

Cable gland M12 x 1.5
Cable 1 m

Measuring element

Bourdon tube
≤ 60 bar: "C" type tube, Copper alloy
> 60 bar: helical tube, stainless steel 316 Ti/316 L

movement

Brass

Dial

Aluminium, white
Scaling: black

Pointer

Aluminium, black

Housing

Stainless steel 304, with blow-out

bayonet bezel

Stainless steel 304

Options

- back flange
- 3-hole fixing, panel mounting bezel
- throttle screw
- Junction box
- Connector
- special scales
- other process connections

window

Plastic (Makrolon), with contact adjustment lock

Supply voltage

DC 5 – 25 V

Current input

≥ 2.1 mA

Switching accuracy

approx. 0.5 % of full scale value

Operating temperature range

-20/+70 °C or corresponding to the respective measuring instruments

Adjustment range

5–95 % measuring range of gauge

Options

- contact systems with safety integrity level SIL 2

Technical Drawings

Bottom connection

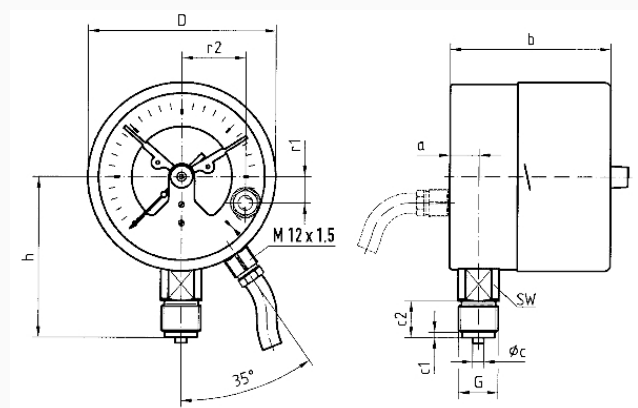

Dimensions (mm)

NG	a	b	b1	∅C	c1	c2	D	G	h	r1	r2	SW
100	15,6	87	90,5	6	3	20	101,5G½B	86	14	34,5	22	
160	17,5	97	100	6	3	20	161,5G½B	116	14	34,5	22	

Versions

Range	Mounting type	Type	Part number
0/60 bar	direct	RF100I IK1 D401	87719401

- in-stock items
- Non-stock items