

Bourdon tube pressure gauges for industrial applications RF100I MK1

Part no. 87622401

Bourdon tube pressure gauges for industrial applications with electrical contact type D4



benefits

- robust stainless steel housing
- excellent readability
- Up to four switching contacts
- available with MK, EK, IK

Application

For gaseous and liquid media which are not highly viscous, do not crystallise and do not attack copper alloys.

Technical Specifications

Type
D4

Nominal size
100

accuracy class (EN 837-1/6)
1.0

ranges (EN 837-1/5)
see ordering table

application area
 ≤ 600 bar: Full scale value
 > 600 bar: $\frac{3}{4}$ x full scale value
 ≤ 600 bar: 0.9 x full scale value
 > 600 bar: $\frac{2}{3}$ x full scale value
 ≤ 600 bar: 1.3 x full scale value
 > 600 bar: Full scale value

contact types
Magnetic spring contact (MK)

minimum range
MK Single
1.6 bar

Operating temperature range
Medium: max. 60 °C
Ambient: -20/+60 °C

Temperature performance
Indication error when the temperature of the measuring system deviates from the normal temperature of 20 °C:
at rising temperature approx. ± 0.4 %/10 K
falling temperature approx. ± 0.4 %/10 K
of full scale value

Degree of protection
IP 54 (EN 60529)

Connection
Brass, bottom
G $\frac{1}{2}$ B, SW22 (EN 837-1/7.3)

Electrical connection

Cable gland M12 x 1.5
Cable 1 m

Measuring element

Bourdon tube
≤ 60 bar: "C" type tube, Copper alloy
> 60 bar: helical tube, stainless steel 316 Ti/316 L

movement

Brass

Dial

Aluminium, white
Scaling: black

Pointer

Aluminium, black

Housing

Stainless steel 304, with blow-out

bayonet bezel

Stainless steel 304

window

Plastic (Makrolon), with contact adjustment lock

Options

- back flange
- 3-hole fixing, panel mounting bezel
- throttle screw
- Junction box
- Connector
- special scales
- other process connections

Supply voltage

max. AC/DC 250 V

Making current and breaking current

max. 1 A

Continuous current

max. 0.6 A

Switch rating

max. 50 VA, max. 30 W

Contact

Ag80 Ni20 Au 10 µm

Switching accuracy

approx. 2–5 % of full scale value

Operating temperature range

-20/+70 °C or corresponding to the respective measuring instruments

Adjustment range

5–95 % measuring range of gauge

Technical Drawings

Bottom connection

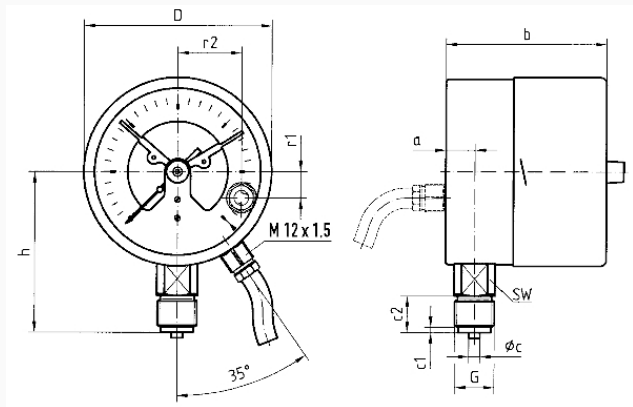

Dimensions (mm)

NG	a	b	b1	∅C	c1	c2	D	G	h	r1	r2	SW
100	15,6	87	90,5	6	3	20	101,5G½B	86	14	14	34,5	22
160	17,5	97	100	6	3	20	161,5G½B	116	14	14	34,5	22

Versions

Range	Mounting type	Type	Part number
0/250 bar	direct	RF100I MK1 D401	87622401

- in-stock items
- Non-stock items