

## Bourdon tube pressure gauge RF63RG IK1

Part no. 87265302

Bourdon tube pressure gauge

### Technical Specifications

**Type**

D3

**Nominal size**

63

**accuracy class (EN 837-1/6)**

1.6

**ranges (EN 837-1/5)**

see ordering table

**Calibration medium**

Nitrogen or dried air

**application area**

static load:  $\frac{3}{4}$  x full scale value  
dynamic load:  $\frac{2}{3}$  x full scale value  
short-term: Full scale value

**Contact type**

inductive contact (IK) Single

**Operating temperature range**

Medium: max. 150 °C  
Ambient: -20/+60 °C

**Temperature performance**

Indication error when the temperature of the measuring system deviates from the normal temperature of 20 °C:  
at rising temperature approx.  $\pm 0.4$  %/10 K  
falling temperature approx.  $\pm 0.4$  %/10 K  
of full scale value

**Degree of protection**

IP 32 (EN 60529)

**Connection**

stainless steel 316 Ti/316 L, bottom

**Measuring element**

Bourdon tube, stainless steel 316 Ti/316 L  
 $\leq 60$  bar: "C" type tube  
> 60 bar: helical tube

**wetted parts**

cleaned,  
flushed with nitrogen,  
electropolished,  
surface roughness  $\leq R_a 0.6 \mu\text{m}$

**movement**

Stainless steel

**Dial**

Aluminium, white  
 Scaling: black  
 label: ultra-pure gas

**Pointer**

Aluminium, black

**Housing**

Stainless steel 304 back blow-out

**push on bezel**

Stainless steel 304, bare metal surface

**window**

Plastic

**Supply voltage**

DC 5 V DC 25 V

**Current input**

≥ 2.1 mA

**Switching accuracy**

approx. 0.5 % of full scale value

**Operating temperature range**

-20/+70 °C or corresponding to the respective measuring instruments

**Adjustment range**

5–95 % measuring range of gauge

**Options**

- contact systems with safety integrity level SIL 2

**Options**

- surface roughness  $R_a$  0.4  $\mu$ m
- Housing polished
- Push on bezel polished
- Electrical contacts
- NG 50
- special scales
- other process connections

**Technical Drawings**

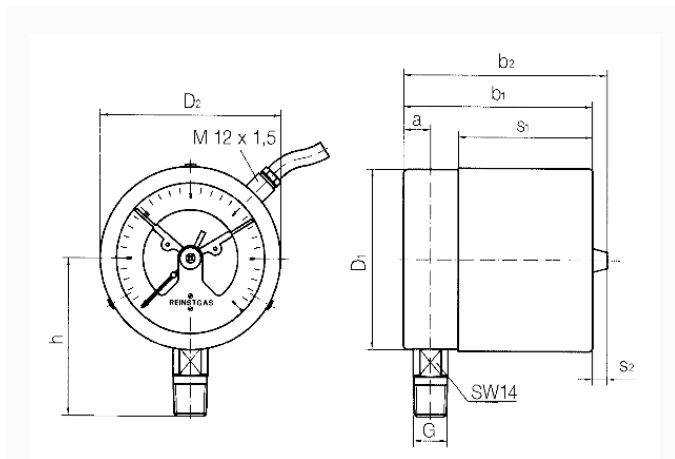

**Dimensions (mm)**

NG	a	b	$\varnothing c$	c1	c2	D	G	h	s	s1	SW
63	9,5	66	5	2	13	64	G $\frac{1}{4}$ B	46	47,5	8	14

## Versions

Range	Mounting type	Type	Part number
0/10 bar	direct	RF63RG IK1 D302	87265302

- in-stock items
- Non-stock items