

Bourdon tube pressure gauge RF63RG IK1

Part no. 87267302

Bourdon tube pressure gauge

Technical Specifications

Type

D3

Nominal size

63

accuracy class (EN 837-1/6)

1.6

ranges (EN 837-1/5)

see ordering table

Calibration medium

Nitrogen or dried air

application area

static load: $\frac{3}{4}$ x full scale value
dynamic load: $\frac{2}{3}$ x full scale value
short-term: Full scale value

Contact type

inductive contact (IK) Single

Operating temperature range

Medium: max. 150 °C
Ambient: -20/+60 °C

Temperature performance

Indication error when the temperature of the measuring system deviates from the normal temperature of 20 °C:
at rising temperature approx. ± 0.4 %/10 K
falling temperature approx. ± 0.4 %/10 K
of full scale value

Degree of protection

IP 32 (EN 60529)

Connection

stainless steel 316 Ti/316 L, bottom

Measuring element

Bourdon tube, stainless steel 316 Ti/316 L
 ≤ 60 bar: "C" type tube
> 60 bar: helical tube

wetted parts

cleaned,
flushed with nitrogen,
electropolished,
surface roughness $\leq R_a 0.6 \mu\text{m}$

movement

Stainless steel

Dial

Aluminium, white
Scaling: black
label: ultra-pure gas

Pointer

Aluminium, black

Housing

Stainless steel 304 back blow-out

push on bezel

Stainless steel 304, bare metal surface

window

Plastic

Supply voltage

DC 5 V DC 25 V

Current input

≥ 2.1 mA

Switching accuracy

approx. 0.5 % of full scale value

Operating temperature range

-20/+70 °C or corresponding to the respective measuring instruments

Adjustment range

5–95 % measuring range of gauge

Options

- contact systems with safety integrity level SIL 2

Options

- surface roughness R_a 0.4 μ m
- Housing polished
- Push on bezel polished
- Electrical contacts
- NG 50
- special scales
- other process connections

Technical Drawings

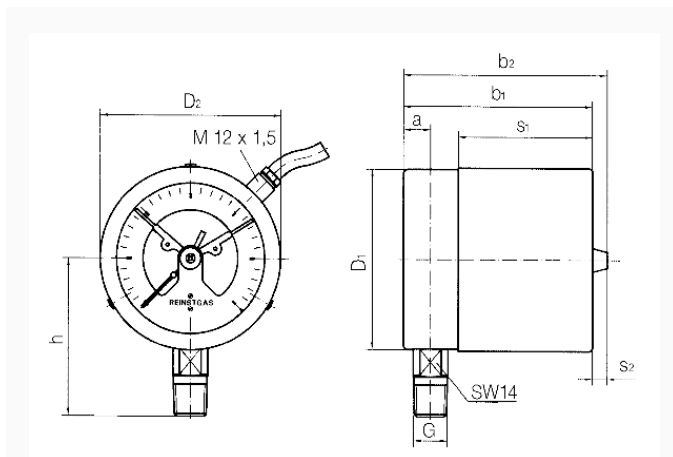

Dimensions (mm)

NG	a	b	$\varnothing c$	c1	c2	D	G	h	s	s1	SW
63	9,5	66	5	2	13	64	G $\frac{1}{4}$ B	46	47,5	8	14

Versions

Range	Mounting type	Type	Part number
0/25 bar	direct	RF63RG IK1 D302	87267302

- in-stock items
- Non-stock items