



Bourdon tube pressure gauge RF63RG IK2

Part no. 87305302

Bourdon tube pressure gauge

Technical Specifications

Type
D3

Nominal size
63

accuracy class (EN 837-1/6)
1.6

ranges (EN 837-1/5)
see ordering table

Calibration medium
Nitrogen or dried air

application area
static load: $\frac{3}{4}$ x full scale value
dynamic load: $\frac{2}{3}$ x full scale value
short-term: Full scale value

Options

- surface roughness R_a 0.4 μm
- Housing polished
- Push on bezel polished
- Electrical contacts
- NG 50
- special scales

Contact type
inductive contact (IK) dual

Operating temperature range
Medium: max. 150 °C
Ambient: -20/+60 °C

Temperature performance
Indication error when the temperature of the measuring system deviates from the normal temperature of 20 °C:
at rising temperature approx. $\pm 0.4 \%$ /10 K
falling temperature approx. $\pm 0.4 \%$ /10 K
of full scale value

Degree of protection
IP 32 (EN 60529)

- other process connections

Technical Drawings

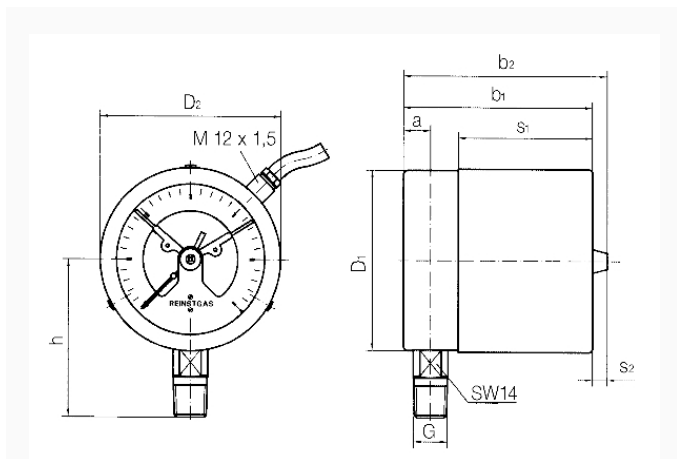

Dimensions (mm)

NG	a	b	∅c	c1	c2	D	G	h	s	s1	SW
63	9,5	66	5	2	13	64	G¼B	46	47,5	8	14

Versions

Range	Mounting type	Type	Part number
-1/+5 bar	direct	RF63RG IK2 D302	87305302

- in-stock items
- Non-stock items