

## Bourdon tube pressure gauge RF63RG IK2

Part no. 87316302

Bourdon tube pressure gauge

### Technical Specifications

**Type**  
D3

**Nominal size**  
63

**accuracy class (EN 837-1/6)**  
1.6

**ranges (EN 837-1/5)**  
see ordering table

**Calibration medium**  
Nitrogen or dried air

**application area**  
static load:  $\frac{3}{4}$  x full scale value  
dynamic load:  $\frac{2}{3}$  x full scale value  
short-term: Full scale value

### Options

- surface roughness  $R_a$  0.4  $\mu\text{m}$
- Housing polished
- Push on bezel polished
- Electrical contacts
- NG 50
- special scales

**Contact type**  
inductive contact (IK) dual

**Operating temperature range**  
Medium: max. 150 °C  
Ambient: -20/+60 °C

**Temperature performance**  
Indication error when the temperature of the measuring system deviates from the normal temperature of 20 °C:  
at rising temperature approx.  $\pm 0.4 \%$ /10 K  
falling temperature approx.  $\pm 0.4 \%$ /10 K  
of full scale value

**Degree of protection**  
IP 32 (EN 60529)

- other process connections

### Technical Drawings

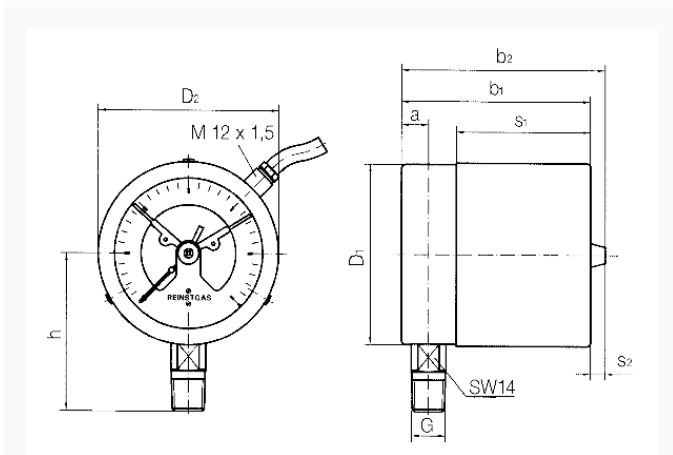

#### Dimensions (mm)

NG	a	b	∅c	c1	c2	D	G	h	s	s1	SW
63	9,5	66	5	2	13	64	G¼B	46	47,5	8	14

### Versions

Range	Mounting type	Type	Part number
0/16 bar	direct	RF63RG IK2 D302	87316302

- in-stock items
- Non-stock items