



Bourdon tube pressure gauge RF63RG MK1

Part no. 87366302

Bourdon tube pressure gauge

Technical Specifications

Type
D3

Nominal size
63

accuracy class (EN 837-1/6)
1.6

ranges (EN 837-1/5)
see ordering table

Calibration medium
Nitrogen or dried air

application area
static load: $\frac{3}{4}$ x full scale value
dynamic load: $\frac{2}{3}$ x full scale value
short-term: Full scale value

Contact type
Magnetic spring contact (MK) Single

Operating temperature range
Medium: max. 150 °C
Ambient: -20/+60 °C

Temperature performance

Indication error when the temperature of the measuring system deviates from the normal temperature of 20 °C:
at rising temperature approx. ± 0.4 %/10 K
falling temperature approx. ± 0.4 %/10 K
of full scale value

Degree of protection
IP 32 (EN 60529)

Connection
stainless steel 316 Ti/316 L, bottom

Measuring element
Bourdon tube, stainless steel 316 Ti/316 L
 ≤ 60 bar: "C" type tube
> 60 bar: helical tube

wetted parts
cleaned,
flushed with nitrogen,
electropolished,
surface roughness $\leq R_a 0.6 \mu\text{m}$

movement
Stainless steel

Dial
Aluminium, white
Scaling: black
label: ultra-pure gas

Pointer

Aluminium, black

Housing

Stainless steel 304 back blow-out

push on bezel

Stainless steel 304, bare metal surface

window

Plastic

Supply voltage

max. AC/DC 250 V

Making current and breaking current

max. 1 A

Continuous current

max. 0.6 A

Switch rating

max. 50/30 VA

Contact

Ag80 Ni20 Au 10 µm

Switching accuracy

approx. 2–5 % of full scale value

Operating temperature range

-20/+70 °C or corresponding to the respective measuring instruments

Adjustment range

5–95 % measuring range of gauge

Options

- surface roughness R_a 0.4 µm
- Housing polished
- Push on bezel polished
- Electrical contacts
- NG 50
- special scales
- other process connections

Technical Drawings

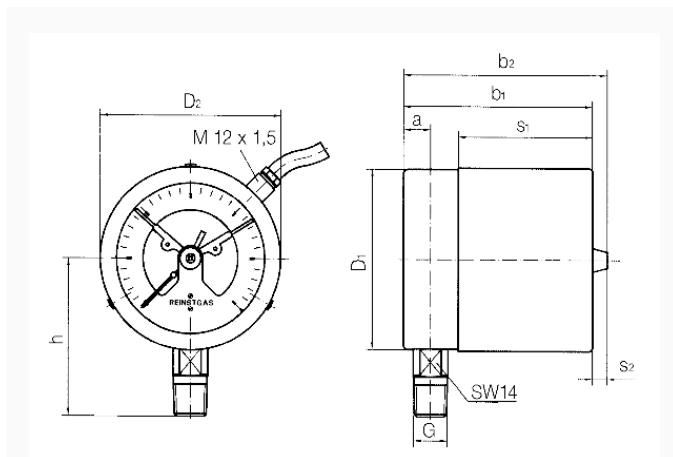

Dimensions (mm)

NG	a	b	$\varnothing c$	c1	c2	D	G	h	s	s1	SW
63	9,5	66	5	2	13	64	G $\frac{1}{4}$ B	46	47,5	8	14

Versions

Range	Mounting type	Type	Part number
0/16 bar	direct	RF63RG MK1 D302	87366302

- in-stock items
- Non-stock items