



## Bourdon tube pressure gauge RF63RG MK1

Part no. 87369302

Bourdon tube pressure gauge

### Technical Specifications

**Type**  
D3

**Nominal size**  
63

**accuracy class (EN 837-1/6)**  
1.6

**ranges (EN 837-1/5)**  
see ordering table

**Calibration medium**  
Nitrogen or dried air

**application area**  
static load:  $\frac{3}{4}$  x full scale value  
dynamic load:  $\frac{2}{3}$  x full scale value  
short-term: Full scale value

**Contact type**  
Magnetic spring contact (MK) Single

**Operating temperature range**  
Medium: max. 150 °C  
Ambient: -20/+60 °C

### Temperature performance

Indication error when the temperature of the measuring system deviates from the normal temperature of 20 °C:  
at rising temperature approx.  $\pm 0.4$  %/10 K  
falling temperature approx.  $\pm 0.4$  %/10 K  
of full scale value

**Degree of protection**  
IP 32 (EN 60529)

**Connection**  
stainless steel 316 Ti/316 L, bottom

**Measuring element**  
Bourdon tube, stainless steel 316 Ti/316 L  
 $\leq 60$  bar: "C" type tube  
> 60 bar: helical tube

**wetted parts**  
cleaned,  
flushed with nitrogen,  
electropolished,  
surface roughness  $\leq R_a 0.6 \mu\text{m}$

**movement**  
Stainless steel

**Dial**  
Aluminium, white  
Scaling: black  
label: ultra-pure gas

**Pointer**

Aluminium, black

**Housing**

Stainless steel 304 back blow-out

**push on bezel**

Stainless steel 304, bare metal surface

**window**

Plastic

**Supply voltage**

max. AC/DC 250 V

**Making current and breaking current**

max. 1 A

**Continuous current**

max. 0.6 A

**Switch rating**

max. 50/30 VA

**Contact**

Ag80 Ni20 Au 10 µm

**Switching accuracy**

approx. 2–5 % of full scale value

**Operating temperature range**

-20/+70 °C or corresponding to the respective measuring instruments

**Adjustment range**

5–95 % measuring range of gauge

**Options**

- surface roughness  $R_a$  0.4 µm
- Housing polished
- Push on bezel polished
- Electrical contacts
- NG 50
- special scales
- other process connections

**Technical Drawings**

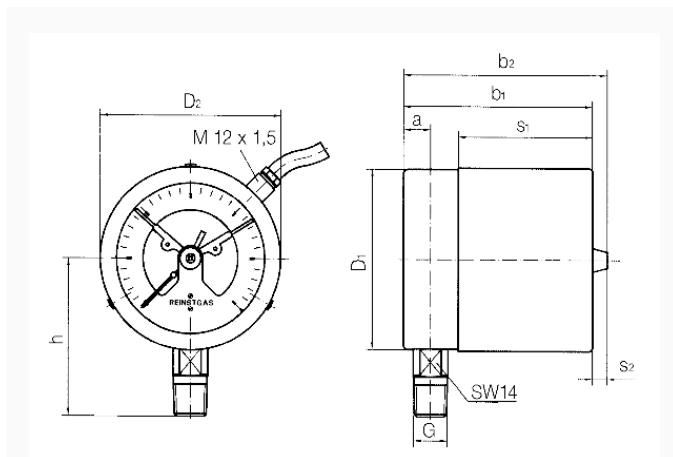

**Dimensions (mm)**

NG	a	b	$\varnothing c$	c1	c2	D	G	h	s	s1	SW
63	9,5	66	5	2	13	64	G $\frac{1}{4}$ B	46	47,5	8	14

## Versions

Range	Mounting type	Type	Part number
0/60 bar	direct	RF63RG MK1 D302	87369302

- in-stock items
- Non-stock items