



## Standard diaphragm pressure gauges PF100

Part no. 85902401

Standard diaphragm pressure gauges Type D4

### benefits

- for low pressure ranges
- high overpressure safety
- robust design
- optional flange connections

### Application

For non-corrosive gaseous and liquid media. With open connection flange also suitable for viscous and polluted media. For measuring gas or vapour, observe the table "Selection Criteria as per EN 837-2" (see appendix)!

### Technical Specifications

**Type**  
D4

**Nominal size**  
100

**accuracy class (EN 837-3/6)**  
1.6

**ranges (EN 837-3/5)**  
see ordering table

**application area**  
static load: Full scale value  
dynamic load: 0.9 x full scale value

**Overpressure safety**  
≤ 0.4 bar  
at least 1.3 x FS

### Operating temperature range

Medium: max. 100 °C  
Ambient: -20/+60 °C

### Temperature performance

Indication error when the temperature of the measuring system deviates from the normal temperature of 20 °C:  
at rising temperature approx. ± 0.8 %/10 K  
falling temperature approx. ± 0.8 %/10 K  
of full scale value

### Degree of protection

IP 54 (EN 60529)

### Connection

Steel, bottom  
G½B, SW22 (EN 837-3/7.3)

### lower measuring flange

steel, galvanised

**upper measuring flange**  
Stainless steel 304

**Measuring element**  
diaphragm  
Measuring flange  
Stainless steel 316 L

**Seal**  
NBR (Perbunan)

**movement**  
Brass

**Dial**  
Aluminium, white  
Scaling: black

**Pointer**  
Aluminium, black

**Housing**  
Stainless steel 304, with blow-out

**bayonet bezel**  
Stainless steel 304

**window**  
Instrument glass

**Options**

- Safety housing
- Overpressure safety 10 x FSD (measuring flange  $\varnothing$  100 to max. 40 bar, measuring flange  $\varnothing$  160 to max. 2.5 bar)
- Glycerine filling ( $\geq$  40 mbar,  $\leq$  250 mbar accuracy class 2.5)
- Electrical contacts
- wetted parts with special coating
- open connection flanges as per EN/ASME

**Technical Drawings**

**bottom connection, measuring flange  $\varnothing$  100**

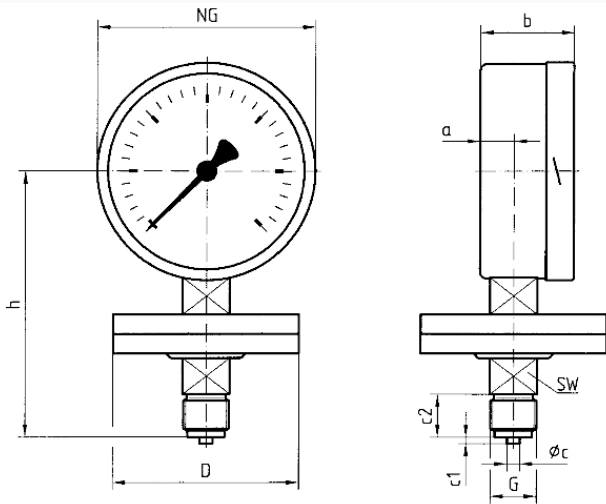

**Dimensions (mm)**

NG	a	b	$\varnothing c$	c1	c2	D	G	h	SW
100	20	55	6	3	20	100	G1½B	127	22

## Versions

Range	Mounting type	Type		Part number
0/16 mbar	direct	PF100 D401	<input type="radio"/>	85902401

- in-stock items
- Non-stock items