

## Stainless steel diaphragm pressure gauges PF100FLO

Part no. 88906402

Stainless steel diaphragm pressure gauge type D4

### benefits

- robust and compact design
- various process connections possible
- flush mounted versions without transmission liquid
- wetted area without seals due to welding
- GOSSTANDART-certified

### Application

For corrosive gaseous and liquid media, also for use in corrosive environments. With open connection flange also suitable for viscous and polluted media; with hygienic connections specially suitable for pharmaceutical processes. For measuring gas or vapour, observe the table "Selection Criteria as per EN 837-2" (see appendix)!

### Technical Specifications

**Type**  
D4

**Nominal size**  
100

**accuracy class (EN 837-3/6)**  
1.6

**ranges (EN 837-3/5)**  
see ordering table

**application area**  
static load: Full scale value  
dynamic load: 0.9 x full scale value

**Overpressure safety**  
≤ 6 bar  
at least 5 x FS

### Operating temperature range

Medium: max. 100 °C  
Ambient: -20/+60 °C

### Temperature performance

Indication error when the temperature of the measuring system deviates from the normal temperature of 20 °C:  
at rising temperature approx. ± 0.8 %/10 K  
falling temperature approx. ± 0.8 %/10 K  
of full scale value

### Degree of protection

IP 54 (EN 60529)

### Connection

stainless steel 316 Ti/316 L, bottom  
open connection flange

### lower measuring flange

stainless steel 316 Ti/316 L

**upper measuring flange**

Stainless steel 316 L

**Measuring element**

diaphragm

≤ 2.5 bar

stainless steel 316 Ti/316 L

**movement**

Stainless steel

**Dial**

Aluminium, white

Scaling: black

**Options**

- Glycerine filling ( $\geq 1$  bar)
- wetted parts with special coating
- clamp connection
- Varivent or BioControl connection
- flush mounted connection flanges as per EN
- open connection flanges as per EN/ANSI
- Electrical contacts ( $\geq 0/0.6$  bar)
- other connection threads

**Pointer**

Aluminium, black

**Housing**

Stainless steel 304, with blow-out

**bayonet bezel**

Stainless steel 304

**window**

Laminated safety glass

**Technical Drawings**

connection flange as per EN 1092-1/B 1/DN 25/PN 40 open, 0/100 mbar to 0/25 bar

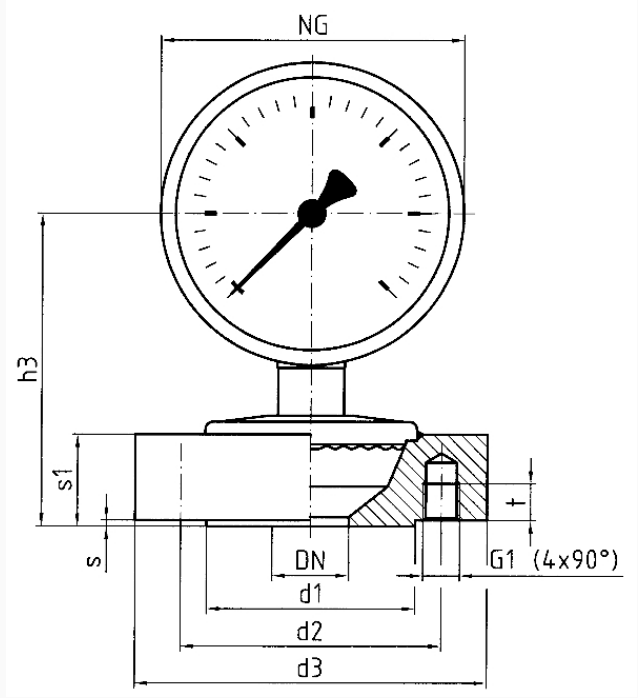

**Dimensions (mm)**

**Dimensions (mm)**

NG	d1	d2	d3	G1	h3	s	s1
100	68	85	115	4xM12	102	2	30
160	68	85	115	4xM12	133	2	30

**Versions**

Range	Mounting type	Type	Part number
0/100 mbar	direct	PF100FLO D402	88906402

- in-stock items
- Non-stock items