



## Standard diaphragm pressure gauges PF100Gly

Part no. 85908801

Standard diaphragm pressure gauges Type D8 with glycerine filling

### benefits

- Overpressure safety 10 bar
- smallest ranges
- robust and compact design
- wetted area without seals due to welding
- Ex version (optional)

### Technical Specifications

**Type**  
D8

**Nominal size**  
100

**accuracy class (EN 837-3/6)**  
1.6

**ranges (EN 837-3/5)**  
see ordering table

**application area**  
static load: Full scale value  
dynamic load: 0.9 x full scale value

**Overpressure safety**  
≤ 0.4 bar  
at least 1.3 x FS

**Operating temperature range**  
Medium: max. 100 °C  
Ambient: -20/+60 °C

### Temperature performance

Indication error when the temperature of the measuring system deviates from the normal temperature of 20 °C:  
at rising temperature approx. ± 0.8 %/10 K  
falling temperature approx. ± 0.8 %/10 K  
of full scale value

**Degree of protection**  
IP 54 (EN 60529)

**Connection**  
Steel, bottom  
G½B, SW22 (EN 837-3/7.3)

**lower measuring flange**  
Steel

**upper measuring flange**  
Stainless steel 304

**Measuring element**  
diaphragm  
measuring flange ø 160  
stainless steel 316 Ti/316 L

**Seal**  
NBR (Perbunan)

**movement**

Brass

**Dial**

Aluminium, white  
Scaling: black

**Pointer**

Aluminium, black

**Housing**

Stainless steel 304, with blow-out

**bayonet bezel**

Stainless steel 304

**window**

Instrument glass

**filling liquid**

Glycerine

**Options**

- Safety housing
- Overpressure safety 10 x FSD (measuring flange  $\varnothing$  100 to max. 40 bar, measuring flange  $\varnothing$  160 to max. 2.5 bar)
- Glycerine filling ( $\geq$  40 mbar,  $\leq$  250 mbar accuracy class 2.5)
- Electrical contacts
- wetted parts with special coating
- open connection flanges as per EN/ASME

**Technical Drawings**

**bottom connection, measuring flange  $\varnothing$  100**

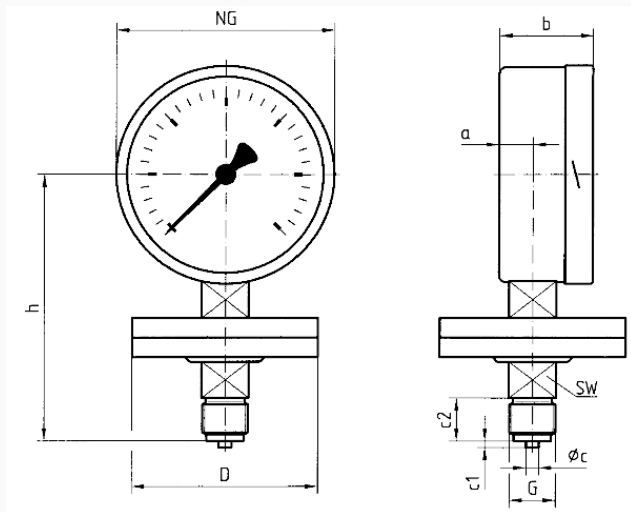

**Dimensions (mm)**

NG	a	b	$\varnothing$ c	c1	c2	D	G	h	SW
100	20	55	6	3	20	100	G1½B	127	22

## Versions

Range	Mounting type	Type		Part number
0/250 mbar	direct	PF100Gly D801	●	85908801

- in-stock items
- Non-stock items