



Diaphragm pressure gauges for chemical applications PF160ChGly

Part no. 85964802

Diaphragm pressure gauges for chemical applications
Type D8 with glycerine filling

benefits

- for low pressure ranges
- high overload protection
- high resistance
- optional flange connections

Technical Specifications

Type
D8

Nominal size
160

accuracy class (EN 837-3/6)
1.6

ranges (EN 837-3/5)
see ordering table

application area
static load: Full scale value
dynamic load: 0.9 x full scale value

Overpressure safety
≤ 6 bar
at least 5 x FS

Operating temperature range
Medium: max. 100 °C
Ambient: -20/+60 °C

Temperature performance

Indication error when the temperature of the measuring system deviates from the normal temperature of 20 °C:
at rising temperature approx. ± 0.8 %/10 K
falling temperature approx. ± 0.8 %/10 K
of full scale value

Degree of protection
IP 54 (EN 60529)

Connection
stainless steel 316 Ti/316 L, bottom
G½B, SW22 (EN 837-3/7.3)

lower measuring flange
stainless steel 316 Ti/316 L

upper measuring flange
Stainless steel 304

Measuring element
diaphragm
measuring flange ø 100
Duratherm

Seal
FPM (Viton)

movement
Stainless steel

Dial
Aluminium, white
Scaling: black

Pointer
Aluminium, black

Housing
Stainless steel 304, with blow-out

bayonet bezel
Stainless steel 304

window
Laminated safety glass

filling liquid
Glycerine

Options

- Safety housing
- Overpressure safety 10 x FSD (measuring flange \varnothing 100 to max. 40 bar, measuring flange \varnothing 160 to max. 2.5 bar)
- Glycerine filling (\geq 40 mbar, \leq 250 mbar accuracy class 2.5)
- Electrical contacts
- wetted parts with special coating
- open connection flanges as per EN/ASME

Technical Drawings

bottom connection, measuring flange \varnothing 160

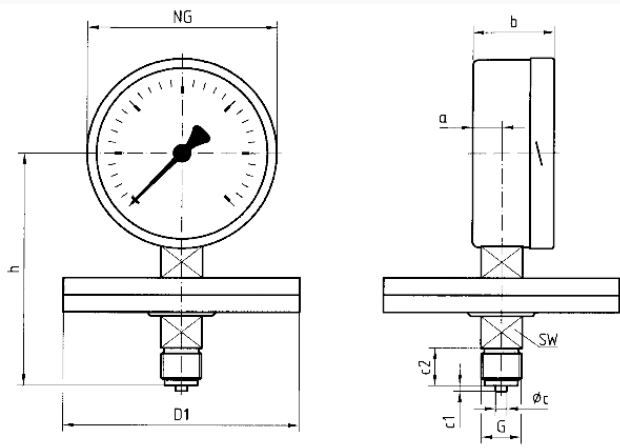

Dimensions (mm)

NG	a	b	$\varnothing c$	c1	c2	D1	G	h	SW
160	20	55	6	3	20	160	G $\frac{1}{2}$ B	156	22

Versions

Range	Mounting type	Type		Part number
0/4 bar	direct	PF160ChGly D802	<input type="radio"/>	85964802

- in-stock items
- Non-stock items