



Standard capsule pressure gauges KP100Dif

Part no. 35567401

Standard capsule pressure gauges for differential pressure type D4

benefits

- Measurement of extremely small differential pressures
- robust design
- static pressures up to 400 mbar
- direct indication of the differential pressure
- many customised versions available

Application

For differential pressure measurement of non-corrosive, gaseous, dry media. Especially suitable for filter loss measurement in air conditioning and ventilation applications.

! For measuring gas or vapour, observe the table "Selection Criteria as per EN 837-2" (see appendix)!

Technical Specifications

Type
D4

Nominal size
100

Function
The "plus" pressure (= high pressure) is applied to the inside of the diaphragm. The "minus" pressure (= low pressure) is applied to the inside of the pressure-tight housing. The pressure difference causes the diaphragm to change its shape, thus generating the movement required to measure the pressure. This displacement is picked up by the movement. The differential pressure is directly indicated by a pointer.

accuracy class
EN 837-3/6
≥ 0/25 mbar
1.6

ranges (EN 837-3/5)
see ordering table

application area
static load: Full scale value
dynamic load: 0.9 x full scale value

Overpressure safety
Full scale value

maximum static pressure
400 mbar

Operating temperature range
Medium: max. 60 °C
Ambient: -20/+60 °C

Temperature performance

Indication error when the temperature of the measuring system deviates from the normal temperature of 20 °C:
at rising temperature approx. $\pm 0.6 \%$ /10 K
falling temperature approx. $\pm 0.6 \%$ /10 K
of full scale value

Degree of protection

IP 66 (EN 60529)

Connection

stainless steel 316 Ti/316 L
bottom, parallel, one behind the other
2 x G $\frac{1}{2}$ B, SW22 (EN 837-3/7.3)

Measuring element (wetted part)

Capsule element, CuBe alloy

Movement (wetted part)

Brass

Options

- back flange
- 3-hole fixing, panel mounting bezel
- hose connections
- special scales
- other process connections

Zero correction

from the front

Seal (wetted part)

NBR (Perbunan)

Dial (wetted part)

Aluminium, white
Scaling: black

Pointer (wetted part)

Aluminium, black

Housing (wetted part)

Stainless steel 304

bayonet bezel

Stainless steel 304

Window (wetted part)

Plastic (PMMA)

Technical Drawings

NG 100/160 – bottom connection

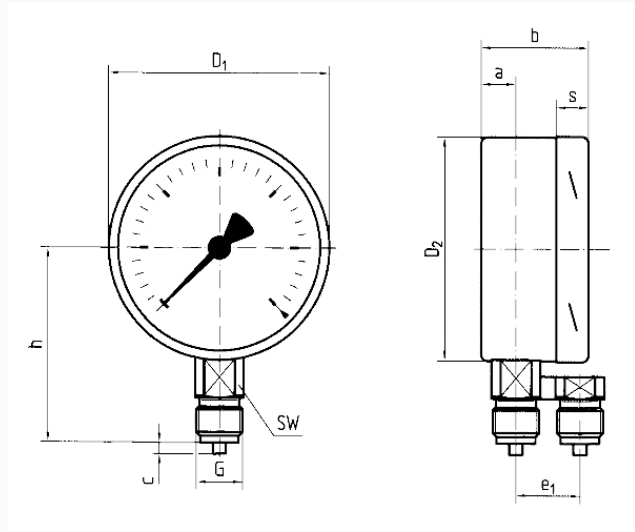

Dimensions (mm)

NG	a	b	c	D1	D2	e1	G	h	s	SW
100	16	49	3	101	99	32	G½B	86	20	22
160	16	49	3	161	159	32	G½B	118	20	22

Versions

		housing ø	Housing	accura- cy class	Connec- tion	Ausrich- tung	Range	Type	Part no.
KP100Dif	D401	100 mm	Stain- less steel 304	1.6	2 x G½B		0/40 mbar	KP100Dif D401 ●	35567401

- in-stock items
- Non-stock items