



## Spring-diaphragm pressure gauges for chemical applications MFW100ChDif

Part no. 88109402

Standard spring-diaphragm pressure gauges for differential pressure - overload protected

### benefits

- direct indication of the differential pressure
- high overload protection
- compact design
- high resistance to chemicals
- Electrical contacts optional

### Application

For differential pressure measurement at low differential pressure and high static pressure. For corrosive gaseous and liquid media which are not highly viscous, also for use in corrosive environments. Particularly suitable for monitoring filters, pumps and pipe systems.

### Technical Specifications

#### Type

MFW ChDif D402

#### Nominal size

100

#### Function

The pressures act on two pressure chambers separated by an elastic diaphragm. If there are different pressures in the chambers, the diaphragm is axially displaced against a compression spring. This is transmitted to the movement by means of a rod. The differential pressure is directly indicated by a pointer. The diaphragm is held by a metallic support which results in an overpressure safety of up to 25 bar at both sides.

#### accuracy class (EN 837-3/6)

2.5

#### ranges (EN 837-3/5)

see ordering table

#### maximum static pressure

25 bar

#### Overpressure safety

up to the maximum static pressure at both ends

#### Operating temperature range

Medium: max. 60 °C

Ambient: -20/+60 °C

#### Temperature performance

Indication error when the temperature of the measuring system deviates from the normal temperature of 20 °C:  
at rising temperature approx.  $\pm 0.5 \%$ /10 K  
falling temperature approx.  $\pm 0.5 \%$ /10 K  
of full scale value

#### Degree of protection

IP 54 (EN 60529)

**Connection**

stainless steel 316 Ti/316 L  
MFW ChDif  
bottom, parallel next to each other

**Measuring element**

Compression spring, Stainless steel 301

**diaphragm**

FKM (Viton)

**Measuring flange**

stainless steel 316 Ti/316 L

**movement**

Stainless steel

**Dial**

Aluminium, white  
Scaling: black

**Pointer**

Aluminium, black

**Housing**

Stainless steel 304

**bayonet bezel**

Stainless steel 304

**window**

Laminated safety glass

**Options**

- Back flange (MF 100)
- Electrical contacts (MFW 100)
- special scales
- other process connections

**Technical Drawings**

**Bottom connection**

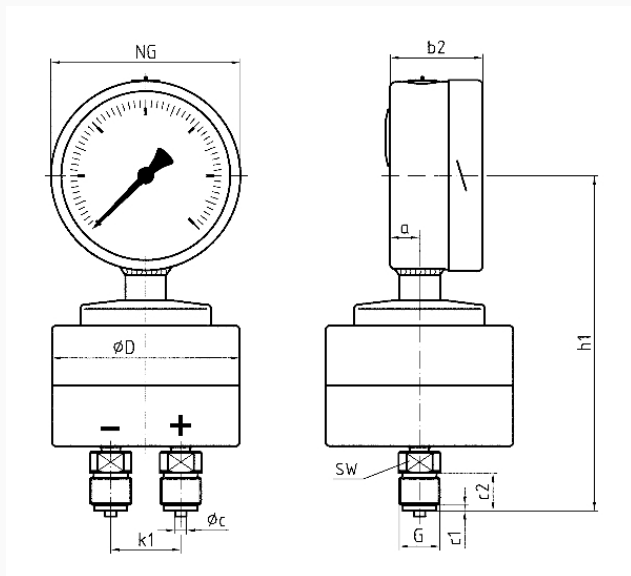

**Dimensions (mm)**

NG	a	b2	øc	c1	c2	øD	G	h1	k1	SW
100	16	49	6	3	20	99	G½B	177	37	22

**Versions**

Type	housing ø	Housing	accuracy class	Con- nection	Ausrich- tung	Range	Type	Type	Part no.
MFW100C Dif D402	100 mm	Stain- less steel 304	2.5	2 x G½B		0/1 bar	MFW100C Dif	D402	88109402

- in-stock items
- Non-stock items