



Spring-diaphragm pressure gauges for chemical applications MFW100ChDif

Part no. 88112402

Standard spring-diaphragm pressure gauges for differential pressure - overload protected

benefits

- direct indication of the differential pressure
- high overload protection
- compact design
- high resistance to chemicals
- Electrical contacts optional

Application

For differential pressure measurement at low differential pressure and high static pressure. For corrosive gaseous and liquid media which are not highly viscous, also for use in corrosive environments. Particularly suitable for monitoring filters, pumps and pipe systems.

Technical Specifications

Type

MFW ChDif D402

Nominal size

100

Function

The pressures act on two pressure chambers separated by an elastic diaphragm. If there are different pressures in the chambers, the diaphragm is axially displaced against a compression spring. This is transmitted to the movement by means of a rod. The differential pressure is directly indicated by a pointer. The diaphragm is held by a metallic support which results in an overpressure safety of up to 25 bar at both sides.

accuracy class (EN 837-3/6)

2.5

ranges (EN 837-3/5)

see ordering table

maximum static pressure

25 bar

Overpressure safety

up to the maximum static pressure at both ends

Operating temperature range

Medium: max. 60 °C

Ambient: -20/+60 °C

Temperature performance

Indication error when the temperature of the measuring system deviates from the normal temperature of 20 °C:
at rising temperature approx. $\pm 0.5 \%$ /10 K
falling temperature approx. $\pm 0.5 \%$ /10 K
of full scale value

Degree of protection

IP 54 (EN 60529)

Connection

stainless steel 316 Ti/316 L
MFW ChDif
bottom, parallel next to each other

Measuring element

Compression spring, Stainless steel 301

diaphragm

FKM (Viton)

Measuring flange

stainless steel 316 Ti/316 L

movement

Stainless steel

Dial

Aluminium, white
Scaling: black

Pointer

Aluminium, black

Housing

Stainless steel 304

bayonet bezel

Stainless steel 304

window

Laminated safety glass

Options

- Back flange (MF 100)
- Electrical contacts (MFW 100)
- special scales
- other process connections

Technical Drawings

Bottom connection

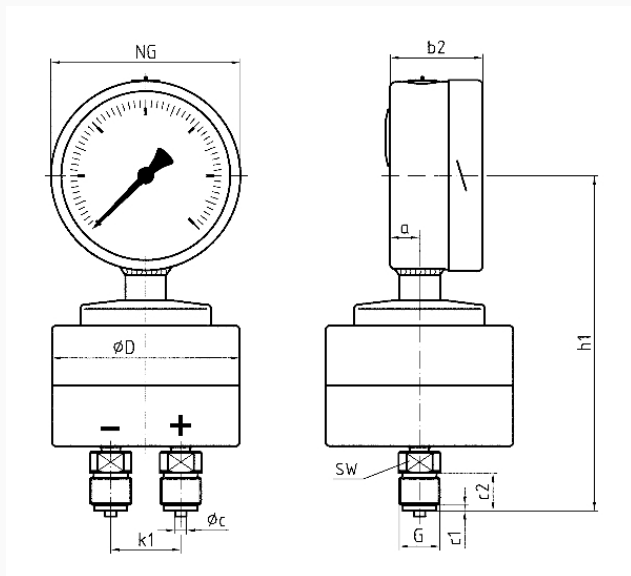

Dimensions (mm)

NG	a	b2	øc	c1	c2	øD	G	h1	k1	SW
100	16	49	6	3	20	99	G½B	177	37	22

Versions

Type	housing ø	Housing	accuracy class	Con- nection	Ausrich- tung	Range	Type	Type	Part no.
MFW100C Dif D402	100 mm	Stain- less steel 304	2.5	2 x G½B		0/4 bar	MFW100C Dif	D402	● 88112402

● in-stock items

● Non-stock items