

## Spring-diaphragm pressure gauges for chemical applications MFW100ChDif MK1

Part no. 88132402

Standard spring-diaphragm pressure gauges for differential pressure - overload protected

### benefits

- direct indication of the differential pressure
- high overload protection
- compact design
- high resistance to chemicals
- Electrical contacts optional

### Technical Specifications

#### Type

MFW ChDif D402

#### Nominal size

100

#### accuracy class (EN 837-3/6)

2.5

#### ranges (EN 837-3/5)

see ordering table

#### maximum static pressure

25 bar

#### Overpressure safety

up to the maximum static pressure at both ends

#### Operating temperature range

Ambient: -20/+60 °C

#### Degree of protection

IP 54 (EN 60529)

#### Connection

stainless steel 316 Ti/316 L

MFW ChDif

bottom, parallel next to each other

#### Measuring element

Compression spring, Stainless steel 301

#### diaphragm

FKM (Viton)

#### Measuring flange

stainless steel 316 Ti/316 L

#### movement

Stainless steel

#### Dial

Aluminium, white

Scaling: black

#### Pointer

Aluminium, black

#### Housing

Stainless steel 304

**bayonet bezel**  
Stainless steel 304

**window**  
Laminated safety glass

**Technical Drawings**

**Bottom connection, with electrical contact**

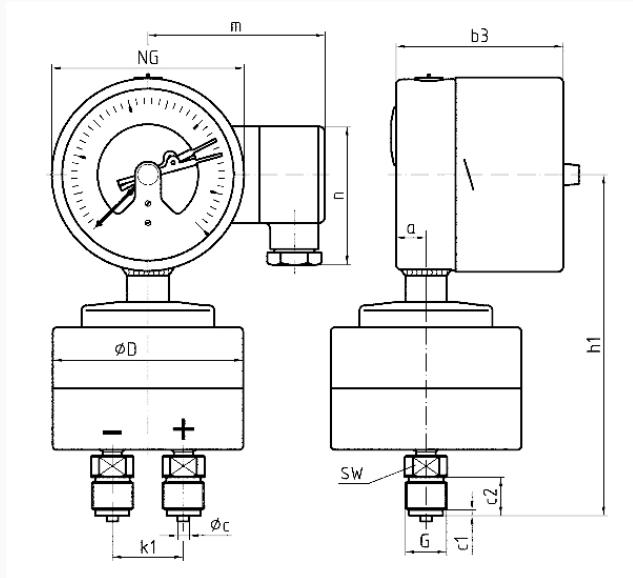

**Dimensions (mm)**

NG	a	b3	Øc	c1	c2	ØD	G	h1	k1	m	n	SW
100	16	87	6	3	20	99	G½B	177	37	92	72	22

**Versions**

Type	housing ø	Housing	accuracy class	Conne- ction	Ausrich- tung	Range	Type	Type	Part no.
MFW100C Dif MK1 D402	100 mm	Stain- less steel 304	2.5	2 x G½B		0/4 bar	MFW100C Dif MK1	D402	● 88132402

- in-stock items
- Non-stock items