



Magnetic piston pressure gauges MAG80Dif

Part no. 88003312

Magnetic piston pressure gauges for differential pressure - high overload protection

benefits

- compact and robust stainless steel measuring system
- max. static pressure PN 100, 250, 400
- Leak-proof due to mechanical separation of pressure chamber and display
- various connection types
- easy retrofitting of electrical contacts without intervention in the measuring system

Application

For differential pressure measurements at very high static pressures. For gaseous and liquid, non-adhesive media that are not highly viscous. Particularly suitable for monitoring filters, pumps, pipe systems and cooling circuits.

Technical Specifications

Type

MAG80Dif D312

Nominal size

80

accuracy

± 3 % of full scale value
(at increasing differential pressure)

ranges (EN 837-3/5)

see ordering table

maximum static pressure

100 bar

Overpressure safety

up to the maximum static pressure at both ends

Operating temperature range

Medium: max. 80 °C
Ambient: 0/80 °C

Degree of protection

IP 65 (EN 60529)

Connection (wetted part)

Stainless steel 316, on left and right sides, opposite each other

Connection cover

plastic, glass-fibre reinforced, black

Measuring element (wetted part)

Compression spring, Stainless steel 301

Magnetic piston (wetted part)

Stainless steel 316/strontium ferrite

Seal (wetted part)

NBR (Perbunan)

Dial

Aluminium, white
dual scale (bar/psi)
Scaling: black/red
scale angle: 90 °

Pointer

Aluminium, black

Housing

Stainless steel 304, with rubber sealing ring at the front

window
Instrument glass

Options

- Mounting plate with fixing clamp
- 3-hole fixing, panel mounting bezel
- max. static pressure PN 250/400
- other connection threads
- other connection designs
- Window acrylic glass
- Bourdon tube pressure gauge with inductive contact
- Filter in "plus" connection
- Glycerine filling
- Maximum pointer
- special scales

Technical Drawings

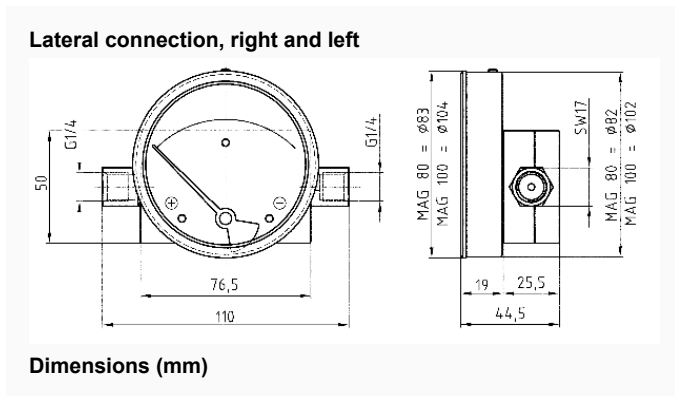

Versions

Type	housing ø	Housing	accuracy class	Conne- ction	Ausrich- tung	Range	Type	Type	Part no.
MA-G80Dif D312	80 mm	Stain- less steel 304		2 x G1/4 female thread		0/0.4 bar	MA-G80Dif	D312	● 88003312

- in-stock items
- Non-stock items