



## Magnetic piston pressure gauges MAG115Dif

Part no. 88003311

Magnetic diaphragm pressure gauges for very low differential pressure

### benefits

- Differential pressure ranges starting at 0/2.5 mbar
- Switching contacts can be retrofitted
- IP 65 degree of protection for pressure gauge and switching contact
- side or back connection
- delivery includes adapter for hose connection and brackets for control panel mounting

### Application

For differential pressure measurement at very low differential pressure. Specially for gaseous media. Particularly suitable for monitoring filters and fans in air supply, air conditioning and clean room applications.

### Technical Specifications

#### Type

MAG115Dif D311

#### Nominal size

115

#### accuracy

± 3 % of full scale value  
(at increasing differential pressure)

#### ranges (EN 837-3/5)

see ordering table

#### maximum static pressure

2.4 bar

#### Overpressure safety

up to the maximum static pressure at both ends

#### Operating temperature range

Medium: max. 60 °C

Ambient: 0/60 °C

#### Degree of protection

IP 65 (EN 60529)

#### Connection (wetted part)

plastic, glass-fibre reinforced, left and right sides, opposing or back  
(use enclosed blind plugs)

#### Measuring element (wetted part)

diaphragm: NBR (Perbunan)  
Compression spring: Stainless steel 301  
Transmission unit: Stainless steel 316

#### Magnet (wetted part)

Strontium ferrite

#### Seal (wetted part)

NBR (Perbunan)

#### Dial

Aluminium, white  
Scaling: black  
scale angle: 90 ° (first graduation mark after zero point at 15 % of full scale value)

#### Pointer

Aluminium, black

#### Housing

Stainless steel 304, with rubber sealing ring at the front

**window**  
Instrument glass

**Options**

- Mounting plate with fixing clamp
- Window acrylic glass
- Bourdon tube pressure gauge with inductive contact
- special scales

**Technical Drawings**

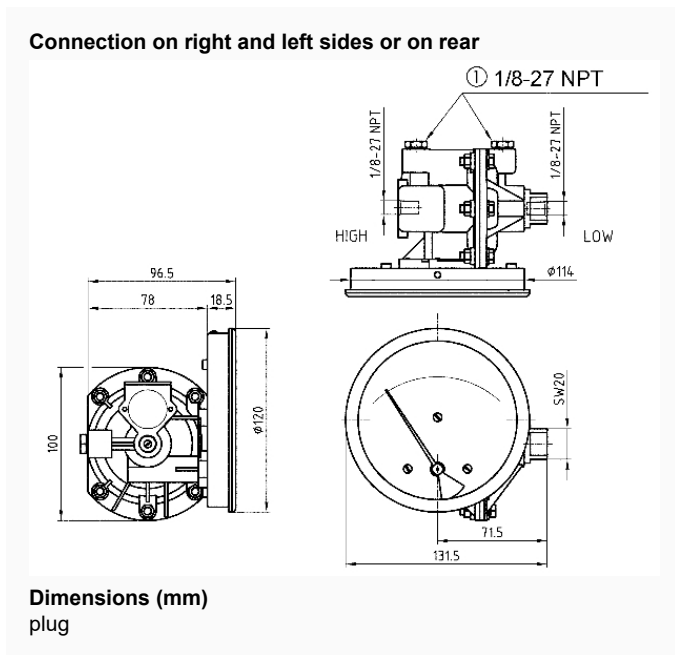

**Versions**

Type	housing ø	Housing	accura- cy class	Connec- tion	Ausrich- tung	Range	Type	Type	Part no.
MA- G115Dif D311	115 mm	Stain- less steel 304		2 x 1/8"NPT Innenge- winde 2 x ho- se con- nection 5 mm		0/4 mbar	MA- G115Dif	D311	88003311

- in-stock items
- Non-stock items