



Magnetic piston pressure gauges MAG115Dif

Part no. 88009311

Magnetic diaphragm pressure gauges for very low differential pressure

benefits

- Differential pressure ranges starting at 0/2.5 mbar
- Switching contacts can be retrofitted
- IP 65 degree of protection for pressure gauge and switching contact
- side or back connection
- delivery includes adapter for hose connection and brackets for control panel mounting

Application

For differential pressure measurement at very low differential pressure. Specially for gaseous media. Particularly suitable for monitoring filters and fans in air supply, air conditioning and clean room applications.

Technical Specifications

Type

MAG115Dif D311

Nominal size

115

accuracy

± 3 % of full scale value
(at increasing differential pressure)

ranges (EN 837-3/5)

see ordering table

maximum static pressure

2.4 bar

Overpressure safety

up to the maximum static pressure at both ends

Operating temperature range

Medium: max. 60 °C

Ambient: 0/60 °C

Degree of protection

IP 65 (EN 60529)

Connection (wetted part)

plastic, glass-fibre reinforced, left and right sides, opposing or back
(use enclosed blind plugs)

Measuring element (wetted part)

diaphragm: NBR (Perbunan)
Compression spring: Stainless steel 301
Transmission unit: Stainless steel 316

Magnet (wetted part)

Strontium ferrite

Seal (wetted part)

NBR (Perbunan)

Dial

Aluminium, white
Scaling: black
scale angle: 90 ° (first graduation mark after zero point at 15 % of full scale value)

Pointer

Aluminium, black

Housing

Stainless steel 304, with rubber sealing ring at the front

window
Instrument glass

Options

- Mounting plate with fixing clamp
- Window acrylic glass
- Bourdon tube pressure gauge with inductive contact
- special scales

Technical Drawings

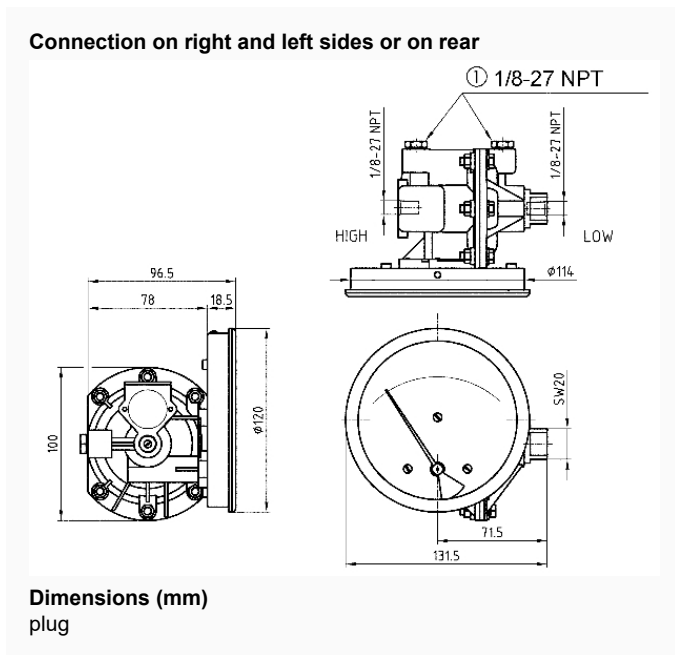

Versions

Type	housing ø	Housing	accura- cy class	Connec- tion	Ausrich- tung	Range	Type	Type	Part no.
MA- G115Dif D311	115 mm	Stain- less steel 304		2 x 1/8"NPT Innenge- winde 2 x ho- se con- nection 5 mm		0/60 mbar	MA- G115Dif	D311	● 88009311

- in-stock items
- Non-stock items