



Magnetic piston pressure gauges MAG115Dif RK1.W

Part no. 88017311

Magnetic piston pressure gauges

benefits

- Differential pressure ranges starting at 0/2.5 mbar
- IP 65 degree of protection for pressure gauge and switching contact
- side or back connection
- delivery includes adapter for hose connection and brackets for control panel mounting

Technical Specifications

Type

MAG115Dif RK1.W D311

Nominal size

115

accuracy

± 3 % of full scale value
(at increasing differential pressure)

ranges

0/16 mbar

Options

- Mounting plate with fixing clamp
- Window acrylic glass
- special scales

Overpressure safety

up to the maximum static pressure at both ends

maximum static pressure

2.4 bar

Operating temperature range

Medium: max. 60 °C
Ambient: 0/60 °C

Degree of protection

IP 65 (EN 60529)

Technical Drawings

connection on right and left sides or on rear, with electrical contact

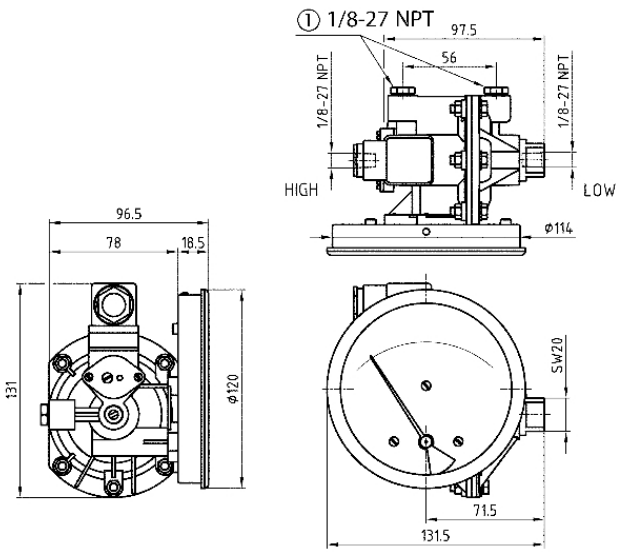

Dimensions (mm)
plug

Versions

Type	housing ø	Housing	accuracy class	Conne- ction	Ausrich- tung	Range	Type	Type	Part no.
MA-G115Dif RK1.W D311	115 mm	Stain- less steel 304		2 x 1/8"NPT Innenge- winde 2 x ho- se con- nection 5 mm		0/16 mbar	MA-G115Dif RK1.W	D311	● 88017311

- in-stock items
- Non-stock items