



Standard Bourdon tube pressure gauges RF100Dif

Part no. 85613201

Standard Bourdon tube pressure gauges for differential pressure type D2

benefits

- Indication of plus pressure, minus pressure and differential pressure
- excellent price/performance ratio
- two independent Bourdon tube systems
- Housing and wetted parts also available in stainless steel (option)

Application

For differential pressure measurement of gaseous and liquid media which are not highly viscous, do not crystallize and do not attack copper alloys. Specially suitable for heating systems (supply and return pipes).

! For measuring gas or vapour, observe the table "Selection Criteria as per EN 837-2" (see appendix)!

Technical Specifications

Type

D2

Nominal size

100

Function

The pressures are measured in two independent Bourdon tube systems ("plus" pressure = high pressure, "minus" pressure = low pressure). The pressure is indicated by means of a dial and a pointer. The differential pressure scale covers 50 % of the range of the "plus" pressure and 50 % of the range of the "minus" pressure. The black pointer ("plus" connection) and the red pointer ("minus" connection) at the differential pressure gauge scale allow you to read the pressures in both systems on the fixed scale.

accuracy class (EN 837-1/6)

1.6

ranges (EN 837-1/5)

see ordering table

application area

The maximum pressure in the system must not exceed the full scale value. For good readability, the differential pressure to be measured should not be less than approx. 20 % of the full scale value.

Operating temperature range

Medium: max. 60 °C

Ambient: -20/+60 °C

Temperature performance

Indication error when the temperature of the measuring system deviates from the normal temperature of 20 °C:
 at rising temperature approx. $\pm 0.4 \%$ /10 K
 falling temperature approx. $\pm 0.4 \%$ /10 K
 of full scale value

Degree of protection

IP 32 (EN 60529)

Connection

Brass, bottom, parallel, one behind the other
 2 x G $\frac{1}{2}$ B, SW22 (EN 837-1/7.3)

Measuring element

Bourdon tube, "C" type tube, Copper alloy

movement

Brass

Dial

Aluminium, white
dual scale bar outer - mWC inner
Scaling: black

Pointer

Aluminium, black

dial

Aluminium

Housing

Sheet steel, black

push on bezel

Sheet steel, black

window

Instrument glass

Options

- wetted parts stainless steel
- Housing and push on bezel stainless steel
- Push on bezel sheet steel, black
- Nominal size 160 (type D1, housing plastic)
- back flange (with stainless steel housing only)
- 3-hole fixing, panel mounting bezel
- throttle screw
- special scales
- other process connections

Technical Drawings

Bottom connection

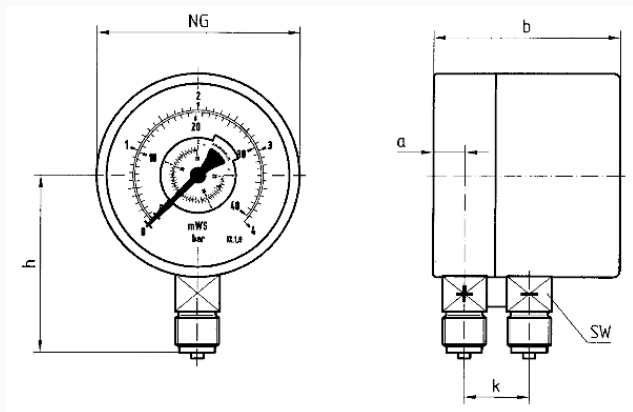

Dimensions (mm)

NG	a	b	G	h	k	SW
100	15,6	84	G½B	86	32	22

Versions

Type	housing ø	Housing	accuracy class	Con- nection	Ausrich- tung	Range	Type	Type	Part no.
RF100Dif D201	100 mm	Sheet steel	1.6	2 x G½B		0/4 bar	RF100Dif	D201	● 85613201

- in-stock items
- Non-stock items