



Standard Bourdon tube pressure gauges RF100Dif

Part no. 85610301

Standard Bourdon tube pressure gauges for differential pressure type D3

benefits

- Indication of plus pressure, minus pressure and differential pressure
- excellent price/performance ratio
- two independent Bourdon tube systems
- Housing and wetted parts also available in stainless steel (option)

Technical Specifications

Type
D3

Nominal size
100

Function
The pressures are measured in two independent Bourdon tube systems ("plus" pressure = high pressure, "minus" pressure = low pressure). The pressure is indicated by means of a dial and a pointer. The differential pressure scale covers 50 % of the range of the "plus" pressure and 50 % of the range of the "minus" pressure. The black pointer ("plus" connection) and the red pointer ("minus" connection) at the differential pressure gauge scale allow you to read the pressures in both systems on the fixed scale.

accuracy class (EN 837-1/6)
1.6

ranges (EN 837-1/5)
see ordering table

application area
The maximum pressure in the system must not exceed the full scale value. For good readability, the differential pressure to be measured should not be less than approx. 20 % of the full scale value.

Operating temperature range

Medium: max. 60 °C
Ambient: -20/+60 °C

Temperature performance

Indication error when the temperature of the measuring system deviates from the normal temperature of 20 °C:
at rising temperature approx. $\pm 0.4 \text{ \%}/10 \text{ K}$
falling temperature approx. $\pm 0.4 \text{ \%}/10 \text{ K}$
of full scale value

Degree of protection

IP 32 (EN 60529)

Connection

Brass, bottom, parallel, one behind the other
2 x G $\frac{1}{2}$ B, SW22 (EN 837-1/7.3)

Measuring element

Bourdon tube, "C" type tube, Copper alloy

movement

Brass

Dial

Aluminium, white
dual scale bar outer - mWC inner
Scaling: black

Pointer

Aluminium, black

dial

Aluminium

Housing

Stainless steel 304

push on bezel

Stainless steel 304

window

Instrument glass

Options

- wetted parts stainless steel
- Housing and push on bezel stainless steel
- Push on bezel sheet steel, black
- Nominal size 160 (type D1, housing plastic)
- back flange (with stainless steel housing only)
- 3-hole fixing, panel mounting bezel
- throttle screw
- special scales
- other process connections

Technical Drawings

Bottom connection

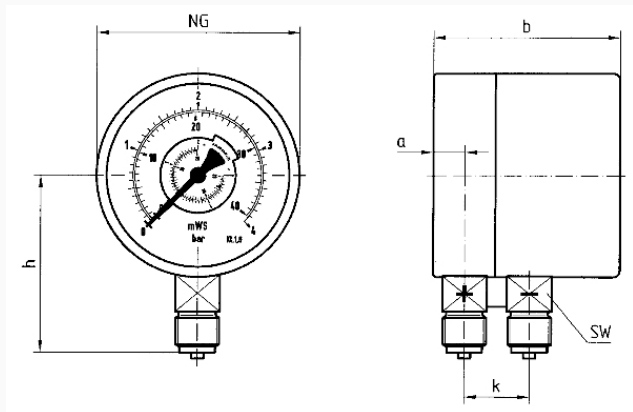

Dimensions (mm)

NG	a	b	G	h	k	SW
100	15,6	84	G $\frac{1}{2}$ B	86	32	22

Versions

Type	housing ø	Housing	accuracy class	Con- nection	Ausrich- tung	Range	Type	Type	Part no.
RF100Dif D301	100 mm	Stain- less steel 304	1.6	2 x G½B		0/1 bar	RF100Dif	D301	● 85610301

● in-stock items

● Non-stock items