

industrial thermometer VMTh 150

Part no. 64337

industrial thermometer

benefits

- extremely robust due to full metal housing
- vibration-resistant glass thermometer
- Stainless steel version possible
- excellent readability due to blue thermometer filling

Application

Heating, industry, mechanical engineering

Technical Specifications

Nominal size
150 mm36 mm

Upper part
Aluminium, V-shaped, polished, anodised brass-coloured. Numbers of measuring range printed in black at the right part of the scale below the anodised layer. Adjustable by means of brass nut (spanner size SW 22) so that readings from any angle are possible.

Glass insert (capillary)
prismatic capillary, completely made of glass, \varnothing 6 mm. Graduation marks of the capillary burnt in, black, completely resistant. Main graduation marks corresponding to the numbers printed on the housing are especially bold and easy to read.

thermometer filling
Standard version: Blue liquid indicating from -60 to +200 °C.

Options

- other ranges
- other stem lengths
- other stem materials

Stem
brass, \varnothing 10 mm, with fixed thread G $\frac{1}{2}$ B. Stainless steel version on request.

accuracy
DIN 16195

ranges °C
0/100

mounting position
Angled 90°

Immersion pipe length
100 mm

- other connection threads
- Upper part anodised aluminium-coloured
- Upper part made of plastic
- thermowells

Technical Drawings

mounting position angled 90°

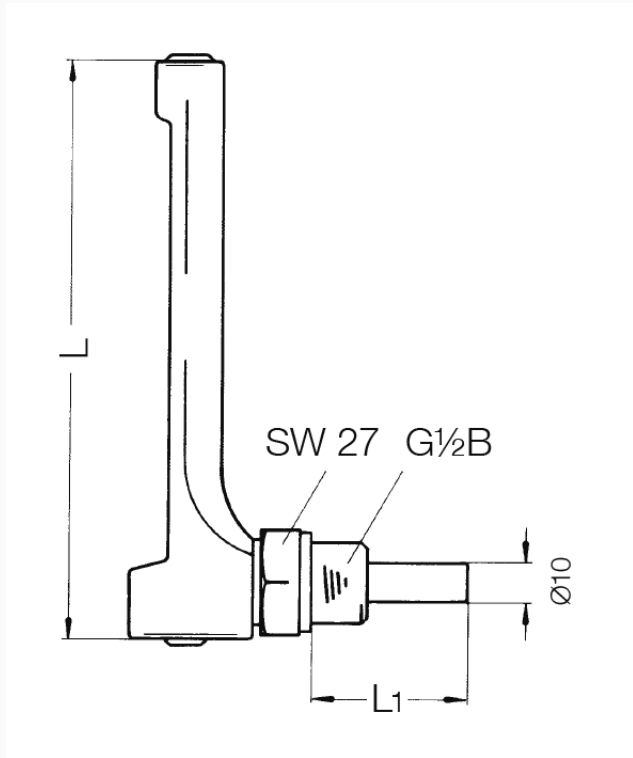

Dimensions (mm)

Typ	L	L ₁			
VMTh 110	110	40	63	100	160
VMTh 150	150	40	63	100	160
VMTh 200	200	40	63	100	160

Versions

	Nominal size	Version	mounting position	Range	Stem length	Type	Part no.
VMTh 150	150 x 36 mm	DIN 16186	Angled 90°	0/100 °C	100 mm	VMTh 150 ●	64337

- in-stock items
- Non-stock items