



Pressure transducers HydroFox® DMU 07 FG

Part no. 31805

Pressure transducers HydroFox® DMU 07 for level measurement

benefits

- flush diaphragm
- without transmission liquid
- mechanically insensitive ceramic sensor
- small temperature error
- high overpressure safety

Application

For electronic, continuous level measurement of liquids and for pressure measurement of liquids and gases in plant construction.

Description

Pressure transducers convert physical pressure into an electrical signal proportional to the pressure. HydroFox® DMU 07 uses a capacitance ceramic measuring cell.

Technical Specifications

Measuring accuracy

Deviation from the characteristic curve according to IEC 60770 – limit point calibration (non-linearity, hysteresis, repeatability)
< ± 0.35 % FSO

Measuring range

0/60 mbar

Overpressure safety

≤ 400 mbar
at least 25 x FS

Operating temperature range

Medium: -40/+125 °C
Ambient: -40/+85 °C
Storage: -40/+100 °C

Temperature error band

≤ 0.1 % FSO/10 K In compensated range -20/+80 °C

dynamic characteristics

Response time: ≤ 200 ms

Process connection

G1½B with flush diaphragm

material

Housing: Stainless steel 316 L
pressure connection: Stainless steel 316 L
diaphragm: ceramic (Al₂O₃ 96 %)
Seal: FKM (Viton)

Supply voltage

DC 9 – 32 V

Output signal

2-wire, 4–20 mA

Load

$R_{max} = [(UB - UB_{min})/0.02 A] \Omega$

Current input

< 21 mA

electrical protection

short circuit proof and protected against reverse polarity

Electrical connection

Connector and junction box as per ISO 4400 (DIN 43650-A)

Degree of protection

IP 65 (EN 60529)

CE conformity

EMC Directive 2014/30/EU

RoHS Directive 2011/65/EU

Pressure Equipment Directive 2014/68/EU

Options

- Pressure connection made of PVDF
- other seal materials
- Field housing (stainless steel 303)
- higher accuracy
- other output signals
- Ex version
 - Ex II 1/2G Ex ia IIC T4 Ga/Gb
 - Ex II 1G Ex ia IIC or IIB T6 oder T4 Ga (metal housing)
 - Ex II 1/2D Ex ia IIIC T 110 °C Da/Db
 - Ex II 10 Ex ia IIIC T 110 °C (metal housing)

Technical Drawings

DMU 07 FG - connection G1½B field housing

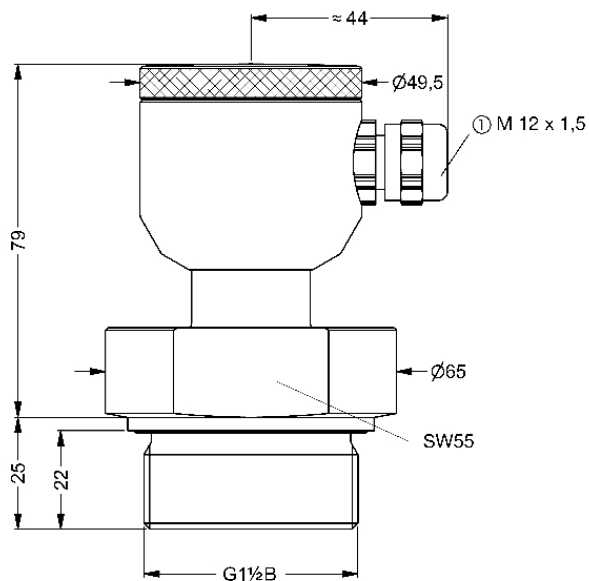

Dimensions (mm)

Cable outlet

Versions

Range	Measuring range	Type	Version	Part no.
	0/60 mbar	HydroFox® DMU 07 FG	<input type="radio"/>	31805

- in-stock items
- Non-stock items